

Public-law institution jointly founded by the
federal states and the Federation

European Technical Assessment Body
for construction products



European Technical Assessment

ETA-17/0200
of 10 October 2024

English translation prepared by DIBt - Original version in German language

General Part

Technical Assessment Body issuing the
European Technical Assessment:

Deutsches Institut für Bautechnik

Trade name of the construction product

Hilti bonded anchor HVZ dynamic

Product family
to which the construction product belongs

Post-installed fasteners in concrete
under fatigue cyclic loading

Manufacturer

HILTI Corporation
Feldkircherstraße 100
9494 SCHAAN
FÜRSTENTUM LIECHTENSTEIN

Manufacturing plant

Hilti Plants

This European Technical Assessment
contains

15 pages including 3 annexes which form an integral part
of this assessment

This European Technical Assessment is
issued in accordance with Regulation (EU)
No 305/2011, on the basis of

EAD 330250-01-0601, Edition 10/2023

This version replaces

ETA-17/0200 issued on 5 October 2020

The European Technical Assessment is issued by the Technical Assessment Body in its official language. Translations of this European Technical Assessment in other languages shall fully correspond to the original issued document and shall be identified as such.

Communication of this European Technical Assessment, including transmission by electronic means, shall be in full. However, partial reproduction may only be made with the written consent of the issuing Technical Assessment Body. Any partial reproduction shall be identified as such.

This European Technical Assessment may be withdrawn by the issuing Technical Assessment Body, in particular pursuant to information by the Commission in accordance with Article 25(3) of Regulation (EU) No 305/2011.

Specific Part

1 Technical description of the product

The Hilti bonded anchor HVZ dynamic is a torque controlled bonded anchor which is anchored into a drilled hole in the concrete. The anchor consists of an anchor rod HAS-(HCR)-TZ, a dynamic-set (nut, sealing washer, spherical washer and nut lock), a foil capsule with mortar Hilti HVU-TZ and the Hilti injection mortar HIT-HY 200-A (V3) or HIT-HY 200-R (V3).

The special formed anchor rod is driven into the foil capsule by machine with simultaneous hammering and turning. The load transfer is realized by mechanical interlock of several cones in the bonding mortar and then via a combination of bonding and friction forces in the concrete. The annular gap between anchor rod and fixture must be filled up with injection mortar HIT-HY 200-A (V3) or HIT-HY 200-R (V3).

The product description is given in Annex A.

2 Specification of the intended use in accordance with the applicable European Assessment Document

The performances given in Section 3 are only valid if the fastener is used in compliance with the specifications and conditions given in Annex B.

The verifications and assessment methods on which this European Technical Assessment is based lead to the assumption of a working life of the fastener of at least 50 years. The indications given on the working life cannot be interpreted as a guarantee given by the producer, but are to be regarded only as a means for choosing the right products in relation to the expected economically reasonable working life of the works.

3 Performance of the product and references to the methods used for its assessment

3.1 Mechanical resistance and stability (BWR 1)

Essential characteristic (Assessment method B: Fatigue limit resistance)	Performance
Characteristic fatigue resistance under cyclic tension loading	
Characteristic steel fatigue resistance $N_{Rk,s,0,\infty}$	See Annex C1
Characteristic pull-out, concrete cone and splitting fatigue resistance $\Delta N_{Rk,p,0,\infty}$ $N_{Rk,c,0,\infty}$ $\Delta N_{Rk,sp,0,\infty}$	
Characteristic fatigue resistance under cyclic shear loading	
Characteristic steel fatigue resistance $\Delta V_{Rk,s,0,\infty}$	See Annex C2
Characteristic concrete edge and concrete pry out fatigue resistance $\Delta V_{Rk,c,0,\infty}$ $\Delta V_{Rk,cp,0,\infty}$	
Characteristic fatigue resistance under cyclic combined tension and shear loading	
Characteristic steel fatigue resistance a_s	See Annex C2

Essential characteristic (Assessment method B: Fatigue limit resistance)	Performance
Load transfer factor for cyclic tension and shear loading	
Load transfer factor ψ_{FN}, ψ_{FV}	See Annexes C1 and C2

4 Assessment and verification of constancy of performance (AVCP) system applied, with reference to its legal base

In accordance with the European Assessment Document EAD 330250-01-0601 the applicable European legal act is: 1996/582/EC.

The system to be applied is: 1

5 Technical details necessary for the implementation of the AVCP system, as provided for in the applicable European Assessment Document

Technical details necessary for the implementation of the AVCP system are laid down in the control plan deposited with Deutsches Institut für Bautechnik.

The following standards and documents are referred to in this European Technical Assessment:

- EN 1993-1-4:2006 + A1:2015 Eurocode 3: Design of steel structures - Part 1-4: General rules - Supplementary rules for stainless steels
- EN 10088-1:2014 Stainless steels - Part 1: List of stainless steels
- EN 206:2013 + A2:2021 Concrete - Specification, performance, production and conformity
- EN 1992-4:2018 Eurocode 2: Design of concrete structures - Part 4: Design of fastenings for use in concrete
- EOTA TR 061 Design Method for fasteners in concrete under fatigue cyclic loading, August 2023
- ETA-03/0032 European Technical Assessment for Hilti bonded anchor HVZ / HVZ R / HVZ HCR, 10 October 2024

Issued in Berlin 10 October 2024 by Deutsches Institut für Bautechnik

Beatrix Wittstock
Head of Section

beglaubigt:
Stiller

Installed condition

HVZ dynamic

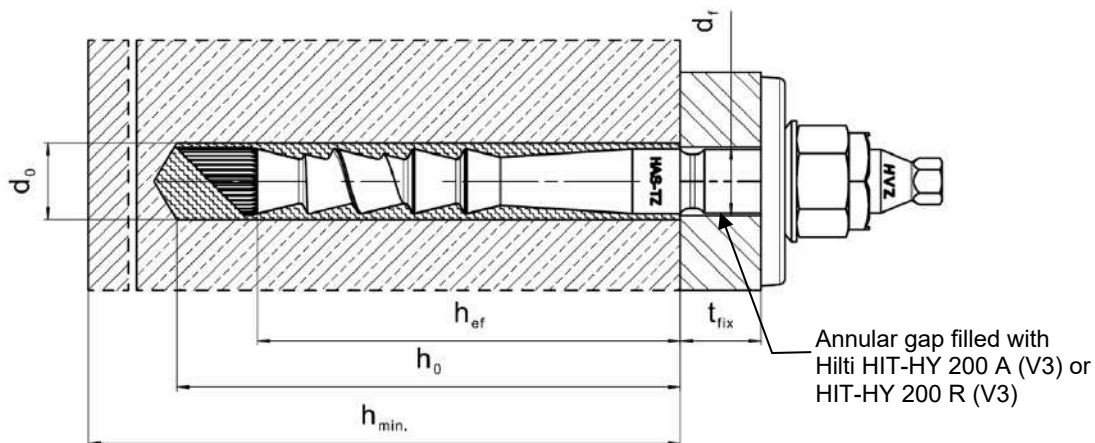

Hilti bonded anchor HVZ dynamic

Product description
Installed condition

Annex A1

Product description: Mortar capsule, steel elements, filling set

Mortar capsule HVU-TZ M10 to M16: Resin and hardener with aggregate

Marking:
HVU-TZ M...
Expiry date mm/yyyy

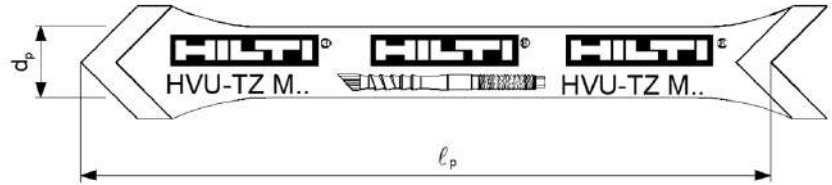

Steel element Hilti HAS-(HCR)-TZ: M10, M12 and M16 with filling set

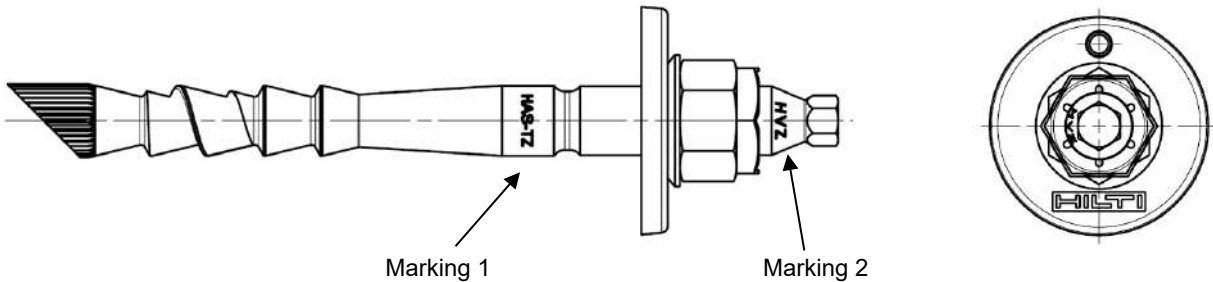

Marking 1: Steel element type, size and fixture thickness; e.g., HAS-TZ M12/50
Marking 2: Fastener type and embedment depth; e.g., HVZ 95

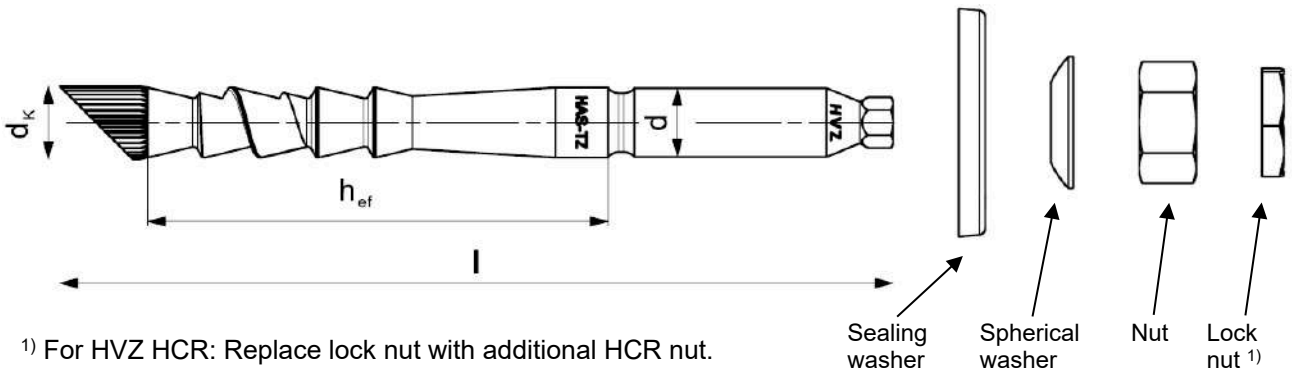

1) For HVZ HCR: Replace lock nut with additional HCR nut.

Hilti bonded anchor HVZ dynamic

Product description
Mortar capsule / Steel element

Annex A2

Hilti Filling Set to fill the annular gap between steel element and fixture

Sealing washer

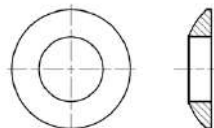
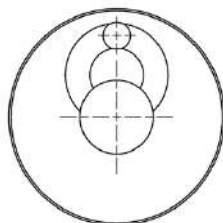
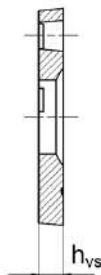
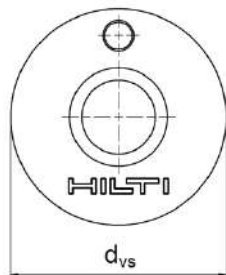

Spherical washer

Filling set

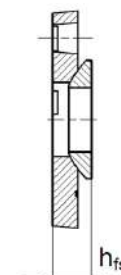

Size		M10	M12	M16
Diameter of sealing washer	d_{vs} [mm]	42	44	52
Thickness of sealing washer	h_{vs} [mm]	5		6
Thickness of Hilti Filling set	h_{fs} [mm]	9	10	11

Table A1: Materials

Designation	Material
Steel elements made of zinc coated steel	
Anchor rod HAS-TZ	$f_{uk} = 800 \text{ N/mm}^2$; $f_{yk} = 640 \text{ N/mm}^2$ Coated, elongation at fracture ($l_0=5d$) > 8% ductile
Washer	Electroplated zinc coated $\geq 5 \mu\text{m}$
Nut	Electroplated zinc coated $\geq 5 \mu\text{m}$
Hilti Filling Set	Sealing washer: Electroplated zinc coated $\geq 5 \mu\text{m}$ Spherical washer: Electroplated zinc coated $\geq 5 \mu\text{m}$ Lock nut: Electroplated zinc coated $\geq 5 \mu\text{m}$
Steel elements made of stainless steel and high corrosion resistant steel Corrosion resistance class III acc. to EN 1993-1-4	
Anchor rod HAS-HCR-TZ	$f_{uk} = 800 \text{ N/mm}^2$; $f_{yk} = 640 \text{ N/mm}^2$ Stainless steel 1.4529, elongation at fracture ($l_0=5d$) > 8% ductile
Washer	High corrosion resistant steel 1.4529, 1.4565 EN 10088-1
Nut	Strength class 80 High corrosion resistant steel 1.4529, 1.4565 EN 10088-1
Hilti Filling Set	Sealing washer: Stainless steel according to EN 10088-1 Spherical washer: Stainless steel according to EN 10088-1 Lock nut: Stainless steel according to EN 10088-1

Hilti bonded anchor HVZ dynamic

Product description
Hilti Filling Set
Materials

Annex A3

Specifications of intended use

Anchorage subject to:

- Fatigue cycling load.
Note: static and quasi-static load according to ETA-03/0032.

Base material:

- Compacted reinforced or unreinforced normal weight concrete without fibres according to EN 206.
- Strength classes C20/25 to C50/60 according to EN 206.
- Cracked and uncracked concrete.

Temperature in the base material:

- **at installation**
0 °C to +40 °C
- **in-service**
Temperature range: -40 °C to +80 °C
(max. long term temperature +50 °C and max. short term temperature +80 °C)

Use conditions (Environmental conditions):

- Structures subject to dry internal conditions (all materials).
- For all conditions according EN 1993-1-4 corresponding to corrosion resistance class III given in Table A1 (stainless steel).

Design:

- Anchorages are designed under the responsibility of an engineer experienced in anchorages and concrete work.
- Verifiable calculation notes and drawings are prepared taking account of the loads to be anchored. The position of the fastener is indicated on the design drawings (e. g. position of the fastener relative to reinforcement or to supports, etc.).
- Anchorages under fatigue cycling load are designed in accordance with: EN 1992-4 and EOTA Technical Report TR 061.

Installation:

- Concrete condition I1: Installation in dry or wet (water saturated) concrete (not in flooded holes) and use in service in dry and wet concrete for all drilling techniques.
- Drilling techniques:
 - Hammer drilling,
 - Hammer drilling with hollow drill bit TE-CD, TE-YD.
- Installation direction D3: Downward, horizontal and upwards (e.g. overhead) installation.
- Fastener installation carried out by appropriately qualified personnel and under the supervision of the person responsible for technical matters of the site.

Hilti bonded anchor HVZ dynamic

Intended use
Specifications

Annex B1

Table B1: Installation parameters

HAS-TZ...			M10x75	M12x95	M16x105	M16x125
HAS-HCR-TZ...			-	M12x95	-	M16x125
Nominal diameter of fastener	d	[mm]	10	12	16	
Nominal diameter of drill bit	d ₀	[mm]	12	14	18	
Max. cutting diameter of drill bit	d _{cut}	[mm]	12,5	14,5	18,5	
Nominal drill hole depth	h ₀	[mm]	90	110	125	145
Effective embedment depth	h _{ef}	[mm]	75	95	105	125
Minimum thickness of concrete member	h _{min}	[mm]	150	190	160	190
Max. diameter of clearance hole in the fixture	d _f	[mm]	14	16	20	
Fixture thickness	t _{fix} ¹⁾	[mm]	6 / 21 / 41	15 / 30 90	19 / 49 / 89	
Installation torque	HAS-TZ	T _{inst} [Nm]	40	50	90	
	HAS-HCR-TZ	T _{inst} [Nm]	50	70	100	
Uncracked concrete	Minimum spacing	s _{min,ucr} [mm]	50	60	70	
	Minimum edge distance	c _{min,ucr} [mm]	50	70	85	
Cracked concrete	Minimum spacing	s _{min,cr} [mm]	50	60	70	
	Minimum edge distance	c _{min,cr} [mm]	50	60	70	

¹⁾ Other fixture thicknesses are possible.

Hilti bonded anchor HVZ dynamic

Intended use
Installation parameters

Annex B2

Table B2: Curing time of mortar capsule HVU-TZ¹⁾

Temperature in the base material T	Curing time: full load t_{cure}
0 °C to 9 °C	1 hour
10 °C to 19 °C	30 min
20 °C to 40 °C	20 min

¹⁾ The curing time data are valid for dry base material only.
In wet base material the curing times must be doubled.

Table B3: Parameters of drilling and setting tool





Fastener	Drill		Setting tool
	Hammer drilling		
HAS-(HCR)-TZ		Hollow drill bit TE-CD, TE-YD	
			
Size	d_0 [mm]	d_0 [mm]	
M10	12	-	TE-C HEX M10
M12	14	14	TE-C HEX M12
M16	18	18	TE-C HEX M16

Table B4: Cleaning alternatives

<p>Manual cleaning (MC): Hilti hand pump for blowing out drill holes.</p>	
<p>Automatic Cleaning (AC): Cleaning is performed during drilling with Hilti TE-CD and TE-YD drilling system including vacuum cleaner.</p>	

Hilti bonded anchor HVZ dynamic

Intended use
Curing time
Drilling, cleaning and setting tools

Annex B3

Installation instruction

Hole drilling

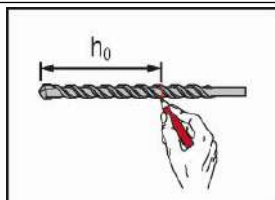

Pre-setting:

Mark drill hole depth h_0 on drill bit TE-C, TE-Y, TE-CD or TE-YD or set the depth gauge of the drilling machine to drill hole depth h_0 .

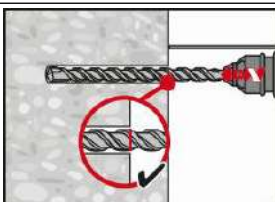

Pre-setting:

Drill hole to the required drilling depth with a hammer drill set in rotation-hammer mode using an appropriately sized carbide drill bit. Do not drill deeper.

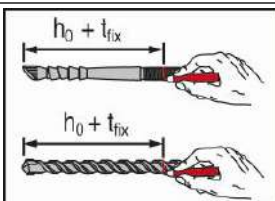

Through-setting:

Mark setting depth $h_0 + t_{fix}$ on element.

Mark drill hole depth $h_0 + t_{fix}$ on drill bit TE-C, TE-Y, TE-CD or TE-YD or set the depth gauge of the drilling machine to drill hole depth $h_0 + t_{fix}$.

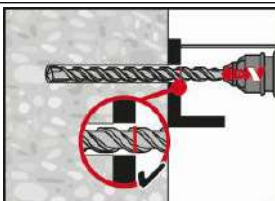

Through-setting:

Drill hole to the required drilling depth with a hammer drill set in rotation-hammer mode using an appropriately sized carbide drill bit. Do not drill deeper.

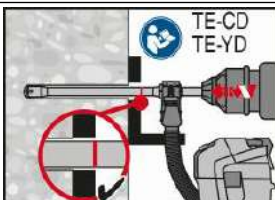

Pre- / Through-setting:

Drill hole to the required embedment depth with an appropriately sized Hilti TE-CD or TE-YD hollow drill bit with Hilti vacuum attachment.

This drilling removes dust while drilling. After drilling is complete, proceed to the "check setting depth" step in the instructions for use.

Drill hole cleaning

Pre- and through-setting: Just before setting the fastener, the drill hole must be free of dust and debris.

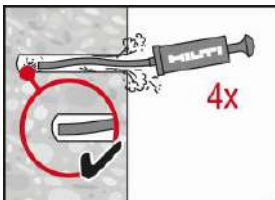

The Hilti hand pump may be used for blowing out drill holes.

Blow out at least 4 times from the back of the drill hole until return air stream is free of noticeable dust.

Hilti bonded anchor HVZ dynamic

Intended use
Installation instructions

Annex B4

Check setting depth (Pre- and through-setting)

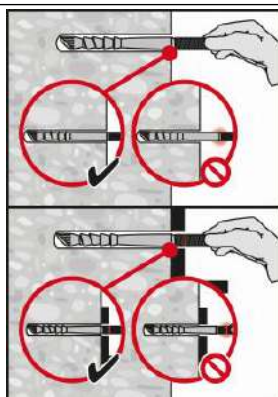

Check the setting depth with the marked element.
The element has to fit in the hole until the required embedment depth (pre-setting) or until the fixture surface.
If it is not possible to insert the element to the required embedment depth, drill deeper.

Setting the element (Pre- and through-setting)

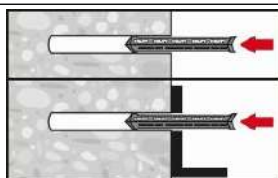

Push the anchor foil capsule with the peak ahead to the back of the hole.

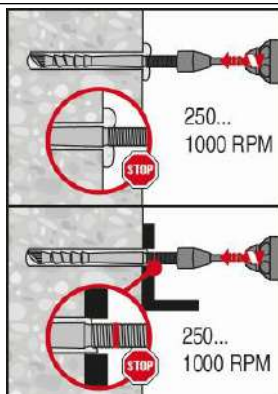

Drive the anchor rod with the setting tool (see Table B3) into the hole, applying moderate pressure and with the hammering action switched on (250 RPM to maximum 1000 RPM).
After reaching the embedment depth switch off setting machine.

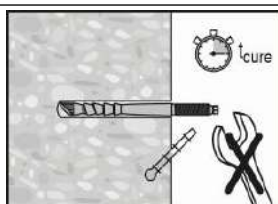

After required curing time t_{cure} (see Table B2) remove excess mortar.

Hilti bonded anchor HVZ dynamic

Intended use
Installation instructions

Annex B5

Final assembly with Filling Set (Pre- and through-setting)

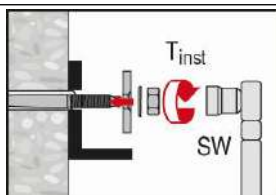

The required installation torque is given in Table B1.

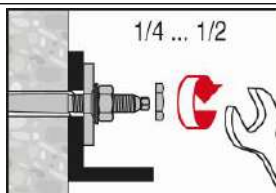

Apply the lock nut and tighten with a 1/4 to 1/2 turn.

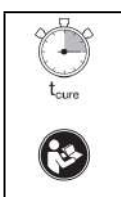
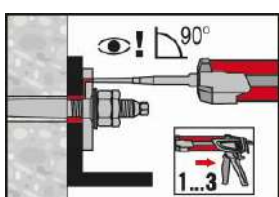

Fill the annular gap between anchor rod and fixture with 1-3 strokes of a Hilti injection mortar HIT-HY 200 A (V3) or HIT-HY 200 R (V3). Follow the installation instructions supplied with the respective Hilti injection mortar. After the required curing time t_{cure} , the fastener can be loaded.

Hilti bonded anchor HVZ dynamic

Intended use
Installation instructions

Annex B6

**Table C1: Essential characteristics under tension fatigue load in concrete
(design method II acc. to TR 061)**

HAS-...	TZ				HCR-TZ	
Size	M10x75	M12x95	M16x105	M16x125	M12x95	M16x125
Steel failure						
Characteristic resistance $\Delta N_{Rk,s,0,\infty}$ [kN]	10,0	18,0	20,0	26,0	15,0	20,8
Partial factor $\gamma_{Ms,N,fat}$ [-]	1,35					
Load transfer factor for fastener group ψ_{FN} [-]	0,69					
Concrete failure						
Characteristic concrete cone resistance	$\Delta N_{Rk,c,0,\infty} = \eta_{k,c,N,fat,\infty} \cdot N_{Rk,c}^{1)}$					
Reduction factor $\eta_{k,c,N,fat,\infty}$ [-]	0,6					
Partial factor $\gamma_{Mc,fat}$ [-]	1,5					
Characteristic splitting resistance	$\Delta N_{Rk,sp,0,\infty} = \eta_{k,sp,N,fat,\infty} \cdot N_{Rk,sp}^{1)}$					
Reduction factor $\eta_{k,sp,N,fat,\infty}$ [-]	0,6					
Partial factor $\gamma_{Mp,N,fat}$ [-]	1,5					
Reduction factor $\eta_{k,p,N,fat,\infty}$ [-]	0,6					
Load transfer factor for fastener group ψ_{FN} [-]	0,69					

¹⁾ $N_{Rk,c}$ and $N_{Rk,sp}$ according to EN 1992-4 and ETA-03/0032.

²⁾ $N_{Rk,p}$ according to ETA-03/0032

Hilti bonded anchor HVZ dynamic

Performance

Essential characteristics under tension fatigue load in concrete
(design method II acc. to TR 061)

Annex C1

**Table C2: Essential characteristics under shear fatigue load in concrete
(design method II acc. to TR 061)**

HAS-...	TZ				HCR-TZ	
Size	M10x75	M12x95	M16x105	M16x125	M12x95	M16x125
Steel failure						
Characteristic resistance $\Delta V_{Rk,s,0,\infty}$ [kN]	4,5	8,5	15,0	15,0	8,5	7,6
Partial factor $\gamma_{Ms,V,fat}$ [-]	1,35					
Load transfer factor for fastener group ψ_{FV} [-]	0,77					
Concrete failure						
Partial factor $\gamma_{Mc,fat}$ [-]	1,5					
Characteristic concrete edge failure resistance	$\Delta V_{Rk,c,0,\infty} = \eta_{k,c,V,fat,\infty} \cdot V_{Rk,c}^{1)}$					
Reduction factor $\eta_{k,c,V,fat,\infty}$ [-]	0,6					
Characteristic pry-out resistance	$\Delta V_{Rk,cp,0,\infty} = \eta_{k,cp,V,fat,\infty} \cdot V_{Rk,cp}^{1)}$					
Reduction factor $\eta_{k,cp,V,fat,\infty}$ [-]	0,6					

¹⁾ $V_{Rk,c}$ and $V_{Rk,cp}$ according to EN 1992-4 and ETA 03/0032.

**Table C3: Essential characteristics under combined fatigue load in concrete
(design method II acc. to TR 061)**

HAS-...	TZ				HCR-TZ	
Size	M10x75	M12x95	M16x105	M16x125	M12x95	M16x125
Steel failure						
Exponent for combined fatigue load α_s [-]	0,75	0,85	0,7	0,7	0,5	0,7
Concrete failure						
Exponent for combined fatigue load α_c [-]	1,5					

Hilti bonded anchor HVZ dynamic

Performance

Essential characteristics under shear and combined fatigue load in concrete
(design method II acc. to TR 061)

Annex C2