



ICC-ES Evaluation Report ESR-1990

Reissued September 2021

This report is subject to renewal September 2023.

DIVISION: 03 00 00—CONCRETE
Section: 03 16 00—Concrete Anchors

DIVISION: 05 00 00—METALS
Section: 05 05 19—Post-Installed Concrete Anchors

REPORT HOLDER:

fischerwerke GmbH & Co. KG

EVALUATION SUBJECT:

fischer FIS EM PLUS ADHESIVE ANCHORING SYSTEM AND POST INSTALLED REINFORCING BAR CONNECTIONS FOR CRACKED AND UNCRACKED CONCRETE

1.0 EVALUATION SCOPE

Compliance with the following codes:

- 2021, 2018, 2015, 2012, and 2009 *International Building Code*® (IBC)
- 2021, 2018, 2015, 2012, and 2009 *International Residential Code*® (IRC)

For evaluation for compliance with codes adopted by the Los Angeles Department of Building and Safety (LADBS), see [ESR-1990 LABC and LARC Supplement](#).

Property evaluated:

Structural

2.0 USES

Adhesive anchors installed using the fischer FIS EM Plus Adhesive Anchoring System are post-installed adhesive anchors and the post-installed reinforcing bars are used as reinforcing bar connections (for development length and splice length) to resist static, wind and earthquake (IBC Seismic Design Categories A through F) tension and shear loads in cracked and uncracked normal-weight concrete having a specified compressive strength, f'_c , of 2,500 psi to 8,500 psi (17.2 MPa to 58.6 MPa).

The anchoring system complies with the requirements for anchors as described in Section 1901.3 of the 2021, 2018 and 2015 IBC, Section 1909 of the 2012 IBC and is an alternative to cast-in-place and post-installed anchors described in Sections 1908 of the 2012 IBC, and Sections 1911 and 1912 of the 2009 IBC. The anchor systems may also be used where an engineered design is submitted in accordance with Section R301.1.3 of the IRC.

The post-installed reinforcing bar connections are an alternative to cast-in-place reinforcing bars governed by ACI 318 and IBC Chapter 19.

3.0 DESCRIPTION

3.1 General:

The fischer FIS EM Plus Adhesive Anchor System is comprised of the following components:

- Adhesive packaged in cartridges: fischer FIS EM Plus 390 S, fischer FIS EM Plus 585 S, or fischer FIS EM Plus 1500 S
- Adhesive mixing and dispensing equipment
- Equipment for hole cleaning and adhesive injection
- An anchor element (continuously threaded steel rod or a deformed steel reinforcing bar)

fischer FIS EM Plus adhesive may only be used with continuously threaded steel rods, internal threaded anchors or deformed steel reinforcing bars described in Tables 2, 3, 4, and 5 and depicted in Figures 4 and 7 of this report. The primary components of the fischer adhesive anchor system, including the fischer FIS EM Plus Adhesive and the anchoring elements are shown in Figure 8 of this report.

The manufacturer's printed installation instructions (MPII), as included with each adhesive unit package, are shown in Figure 6 of this report. The adhesive is also referred to as "mortar" in the installation instructions.

3.2 Materials:

3.2.1 fischer FIS EM Plus Adhesive: fischer FIS EM Plus Adhesive is an injectable epoxy adhesive. The two components are kept separate in a dual-chambered cartridge. The two components combine and react when dispensed through the static mixing nozzle FIS MR Plus (13.2 oz. cartridge) or FIS UMR (19.8 oz. or 50.7 oz. cartridge) attached to the manifold. The system is labeled fischer FIS EM Plus 390 S [13.2 oz (390 mL)], fischer FIS EM Plus 585 S [19.8 oz. (585 mL)] or fischer FIS EM Plus 1500 S [50.7 oz. (1500 ml)]. The cartridge is stamped with the adhesive expiration date. The shelf life, as indicated by the expiration date, corresponds to an unopened pack stored in a dry, dark environment. Storage temperature of the adhesive is 41°F to 86°F (5°C to 30°C). Short-term (less than 48-hour) temperature variations during adhesive storage are permitted as long as the temperature remains between 41°F and 104°F (5°C and 40°C). Under these conditions the shelf life is 36 months.

3.2.2 Hole Cleaning Equipment and Installation

Accessories: Installation accessories include static mixing nozzles, extension tubes, and injection adapters as depicted in Figure 8 of this report.

3.2.2.1 Standard Hole Cleaning: Hole cleaning equipment comprised of steel wire brushes and air nozzles must be used in accordance with Figure 6 of this report.

3.2.2.2 Hole Cleaning with Hollow Drill Bit: When using a hollow drill bit, only the tested hollow drill bits with the manufacturer's designation fischer FHD, Bosch Speed Clean; Hilti TE-CD, TE-YD must be used. The dust extraction system must maintain a minimum volume flow of 36 liters per second (1.27 cubic foot per second). If these requirements are fulfilled, no additional hole cleaning is required

3.2.3 Dispensers: fischer FIS EM Plus adhesive must be dispensed with manual dispensers, cordless electric dispensers or pneumatic dispensers provided by fischerwerke.

3.2.4 Steel Anchor Elements:

3.2.4.1 Threaded steel rods: Threaded steel rods must be clean, continuously threaded rods (all-thread) in diameters as described in Figure 4 of this report. Steel design information for common grades of threaded rod and associated nuts are provided in Table 2 and Table 3 of this report. Carbon steel threaded rods are furnished with a 0.0002-inch-thick (0.005 mm) zinc electroplated coating in accordance with ASTM B633 SC 1, or must be hot-dipped galvanized in accordance with ASTM A153, Class C or D. Steel grade and type (carbon, stainless) for nuts and washers must correspond to the threaded steel rod. Threaded steel rods must be straight and free of indentations or other defects along their length. The end may be stamped with identifying marks and the embedded end may be blunt cut or cut on the bias (chisel point).

3.2.4.2 fischer Threaded Steel Rods FIS A and RG M: fischer FIS A and RG M anchor rods are threaded rods classified as ductile steel elements in accordance with Section 3.2.4.5 of this report. The fischer FIS A is a threaded rod with flat shape on both ends. The fischer RG M is a threaded rod with a chamfer shape on the embedded section and flat or hexagonal end on the concrete surface side, as shown in Tables 2 and 3 and Figure 8. Mechanical properties for the fischer FIS A and RG M are provided in Tables 2 and 3 of this report. The anchor rods are available in diameters as shown in Figure 4. fischer FIS A and RG M anchor rods are produced from carbon steel and furnished with a 0.0002-inch-thick (0.005 mm) zinc electroplated coating or fabricated from R or HCR stainless steel. Steel grade and type (carbon, stainless) for the washers and nuts must match the threaded rods. The threaded rods are marked on the head with an identifying mark (see Figure 7).

3.2.4.3 Steel Reinforcing bars for use in Post-installed Anchor Applications: Steel reinforcing bars are deformed reinforcing bars as described in Table 4 of this report. Figure 4 summarizes reinforcing bar size ranges. The embedded portions of reinforcing bars must be straight, and free of mill scale, rust, mud, oil and other coatings that impair the bond with the adhesive. Reinforcing bars must not be bent after installation, except as set forth in ACI 318-19 Section 26.6.3.2 (b), or ACI 318-14 Section 26.6.3.1 (b) or ACI 318-11 Section 7.3.2, as applicable, with the additional condition that the bars must be bent cold, and heating of reinforcing bars to facilitate field bending is not permitted.

3.2.4.4 fischer internal threaded anchors RG M I: fischer internal threaded anchors RG M I have a profile on the external surface and are internally threaded. Mechanical

properties for fischer internal threaded are provided in Table 5. The anchors are available in diameters and lengths as shown Figure 4. fischer internal threaded anchors RG M I are produced from carbon steel and furnished with a 0.0002-inch-thick (0.005 mm) zinc electroplated coating or fabricated from stainless steel. Specifications for common bolt types that may be used in conjunction with fischer internal threaded anchor RG M I are provided in Table 6. Steel grade and type (carbon, stainless) must match the internal threaded rods. Strength reduction factor, nominal diameter, corresponding to brittle steel elements must be used for fischer internal threaded anchors.

3.2.4.5 Ductility of Anchor Elements: In accordance with ACI 318-19 and ACI 318-14 Section 2.3 or ACI 318-11 D.1, as applicable, in order for a steel element to be considered ductile, the tested elongation must be at least 14 percent and reduction of area must be at least 30 percent. Steel elements with a tested elongation of less than 14 percent or a reduction of area of less than 30 percent, or both, are considered brittle. Values for various steel materials are provided in Tables 2 through 6 of this report. Where values are nonconforming or unstated, the steel must be considered brittle.

3.2.4.6 Steel Reinforcing bars for use in Post-installed Reinforcing Bar Connections: Steel reinforcing bars used in post-installed reinforcing bar connections are deformed bars (rebars) as depicted in Figure 8. Tables 37 and 38 summarize reinforcing bar size ranges. The embedded portions of reinforcing bars must be straight, and free of mill scale, rust, mud, oil and other coatings that impair the bond with the adhesive. Reinforcing bars must not be bent after installation, except as set forth in ACI 318-19 Section 26.6.3.2 (b), or ACI 318-14 Section 26.6.3.1 (b) or ACI 318-11 Section 7.3.2, as applicable, with the additional condition that the bars must be bent cold, and heating of reinforcing bars to facilitate field bending is not permitted.

3.3 Concrete:

Normal-weight concrete must comply with Sections 1903 and 1905 of the IBC. The specified compressive strength of the concrete must be from 2,500 psi to 8,500 psi (17.2 MPa to 58.6 MPa).

4.0 DESIGN AND INSTALLATION

4.1 Strength Design:

4.1.1 General: The design strength of adhesive anchors under the 2021 IBC, as well as the 2021 IRC must be determined in accordance with ACI 318-19 and this report. The design strength of adhesive anchors under the 2018 and 2015 IBC, as well as the 2018 and 2015 IRC, must be determined in accordance with ACI 318-14 and this report. The design strength of adhesive anchors under the 2012, and 2009 IBC, as well as the 2012, and 2009 IRC, must be determined in accordance with ACI 318-11 and this report.

Design parameters are based on ACI 318-19 for use with 2021 IBC, or CI 318-14 for use with 2015 IBC or ACI 318-11 for use with the 2012, and 2009 IBC, as applicable, unless noted otherwise in Sections 4.1.1 through 4.1.11 of this report. Table 1 provides an index to the design strengths.

The strength design of adhesive anchors must comply with ACI 318-19 17.5.1.2, ACI 318-14 17.3.1 or 318-11 D.4.1, as applicable, except as required in ACI 318-19 17.10, ACI 318-14 17.2.3 or 318-11 D.3.3, as applicable.

Design parameters are provided in Tables 7 through 36 of this report. Strength reduction factors, ϕ , as described in ACI 318-19 17.5.3, ACI 318-14 17.3.3 or ACI 318-11 D.4.3, as

applicable, must be used for load combinations calculated in accordance with Section 1605.1 of the 2021 IBC, or Section 1605.2 of the 2018, 2015, 2012 and 2009 IBC, ACI 318-19 and ACI 318-14 5.3 or ACI 318-11 9.2, as applicable. Strength reduction factors, ϕ , as described in ACI 318-11 D.4.4 must be used for load combinations calculated in accordance with ACI 318-11 Appendix C.

4.1.2 Static Steel Strength in Tension: The nominal steel strength of a single anchor in tension, N_{sa} , shall be calculated in accordance with ACI 318-19 17.6.1.2, ACI 318-14 17.4.1.2 or ACI 318-11 D.5.1.2, as applicable, and the associated strength reduction factors, ϕ , in accordance with ACI 318-19 17.5.3, ACI 318-14 17.3.3 or ACI 318-11 D.4.3, as applicable, are given in Tables 7, 12, 17, 22, 27 and 32 of this report for the anchor element types included in this report. See Table 1.

4.1.3 Static Concrete Breakout Strength in Tension: The nominal static concrete breakout strength in tension of a single anchor or group of anchors, N_{cb} or N_{cbg} , must be calculated in accordance with ACI 318-19 17.6.2, ACI 318-14 17.4.2 or ACI 318-11 D.5.2, as applicable, with the following addition:

The basic concrete breakout strength of a single anchor in tension, N_b , must be calculated in accordance with ACI 318-19 17.6.2.2, ACI 318-14 17.4.2.2 or ACI 318-11 D.5.2.2, as applicable, using the values of $K_{c,cr}$, and $K_{c,uncr}$ as described in the tables of this report. Where analysis indicates no cracking in accordance with ACI 318-19 17.6.2.5, ACI 318-14 17.4.2.6 or ACI 318-11 D.5.2.6, as applicable, N_b must be calculated using $K_{c,uncr}$ and $\Psi_{c,N} = 1.0$. See Table 1. For anchors in lightweight concrete see ACI 318-19 17.2.4, ACI 318-14 17.2.6 or ACI 318-11 D.3.6, as applicable. The value of f'_c used for calculation must be limited to 8,000 psi (55 MPa) in accordance with ACI 318-19 17.3.1, ACI 318-14 17.2.7 or ACI 318-11 D.3.7, as applicable. Additional information for the determination of nominal bond strength in tension is given in Section 4.1.4 of this report.

4.1.4 Static Bond Strength in Tension: The nominal static bond strength of a single adhesive anchor or group of adhesive anchors in tension, N_a or N_{ag} , must be calculated in accordance with ACI 318 17.6.5, ACI 318-14 17.4.5 or ACI 318-11 D.5.5, as applicable. Bond strength values ($\tau_{k,uncr} / \tau_{k,cr}$) are a function of the concrete state (cracked or uncracked), temperature range, drilling method (hammer drilling / diamond core drilling / hollow drill bit drilling), hole cleaning (standard / hollow drill bit) and the installation conditions (dry / water-saturated / water-filled hole / underwater), and the level of inspection provided (periodic / continuous). The resulting characteristic bond strength must be multiplied by the associated strength reduction factor ϕ_{nn} and the modification factor K_{nn} , where given, as follows:

DRILLING / CLEANING METHOD	CONCRETE STATE	BOND STRENGTH	PERMISSIBLE INSTALLATION CONDITIONS	ASSOCIATED STRENGTH REDUCTION FACTOR
Hammer drilling	uncracked	$\tau_{k,uncr}$	Dry Holes in Concrete	ϕ_d
			Water Saturated Holes in Concrete	ϕ_{ws}
			Water-filled Holes in Concrete	$\phi_{wf} \cdot K_{wf}$
			Underwater Installation in Concrete	ϕ_{uw}
	cracked	$\tau_{k,cr}$	Dry Holes in Concrete	ϕ_d
			Water Saturated Holes in Concrete	ϕ_{ws}
			Water-filled Holes in Concrete	$\phi_{wf} \cdot K_{wf}$
			Underwater Installation in Concrete	ϕ_{uw}

DRILLING / CLEANING METHOD	CONCRETE STATE	BOND STRENGTH	PERMISSIBLE INSTALLATION CONDITIONS	ASSOCIATED STRENGTH REDUCTION FACTOR
Core drilling	uncracked	$\tau_{k,uncr}$	Dry Holes in Concrete	$\phi_d \cdot K_d$
			Water Saturated Holes in Concrete	$\phi_{ws} \cdot K_{ws}$
			Water-filled Holes in Concrete	$\phi_{wf} \cdot K_{wf}$
			Underwater Installation in Concrete	ϕ_{uw}
	cracked	$\tau_{k,cr}$	Dry Holes in Concrete	$\phi_d \cdot K_d$
			Water Saturated Holes in Concrete	$\phi_{ws} \cdot K_{ws}$
			Water-filled Holes in Concrete	$\phi_{wf} \cdot K_{wf}$
			Underwater Installation in Concrete	ϕ_{uw}
Hollow drilling	uncracked	$\tau_{k,uncr}$	Dry Holes in Concrete	ϕ_d
			Water Saturated Holes in Concrete	ϕ_{ws}
	cracked	$\tau_{k,cr}$	Dry Holes in Concrete	ϕ_d
			Water Saturated Holes in Concrete	ϕ_{ws}

Strength reduction factors, ϕ_{nn} and modification factor K_{nn} , for determination of the bond strength are given in Tables 9 through 11, 14 through 16, 19 through 21, 24 through 26, 29 through 31 and 34 through 36 of this report. Bond strength must also be multiplied by the modification factor K , where given for the applicable diameters. Adjustments to the bond strength may also be taken for increased concrete compressive strength as noted in the footnotes to the corresponding tables noted above. Figure 5 of this report presents a bond strength design selection flowchart.

4.1.5 Static Steel Strength in Shear: The nominal static strength of a single anchor in shear as governed by the steel, V_{sa} , in accordance with ACI 318-19 17.7.1.2, ACI 318-14 17.5.1.2 or ACI 318-11 D.6.1.2, as applicable, and the strength reduction factor, ϕ , in accordance with ACI 318-19

17.5.3, ACI 318-14 17.3.3 or ACI 318-11 D.4.3, as applicable, are given in Tables 7, 12, 17, 22, 27 and 32 for the anchor element types included in this report. See Table 1.

4.1.6 Static Concrete Breakout Strength in Shear: The nominal static concrete breakout strength of a single anchor or group of anchors in shear, V_{cb} or V_{cbg} , must be calculated in accordance with ACI 318-19 17.7.2, ACI 318-14 17.5.2 or ACI 318-11 D.6.2, as applicable, based on information given in Tables 8, 13, 18, 23, 28, and 33 of this report. See Table 1. The basic concrete breakout strength of a single anchor in shear, V_b , must be calculated in accordance with ACI 318-19 17.7.2.2, ACI 318-14 17.5.2.2 or ACI 318-11 D.6.2.2, as applicable, using the values of d_a given in Tables 7, 12, 17, 22, 27 and 32 for the corresponding anchor steel. In addition, h_{ef} must be substituted for l_e . In no case shall l_e exceed $8d$. The value of f'_c shall be limited to a maximum of 8,000 psi (55 MPa) in accordance with ACI 318-19 17.3.1, ACI 318-14 17.2.7 or ACI 318-11 D.3.7, as applicable.

4.1.7 Static Concrete Pryout Strength in Shear: The nominal static pryout strength of a single anchor or group of anchors in shear, V_{cp} or V_{cpg} , shall be calculated in accordance with ACI 318-19 17.7.3, ACI 318-14 17.5.3 or ACI 318-11 D.6.3, as applicable.

4.1.8 Interaction of Tensile and Shear Forces: For designs that include combined tension and shear, the interaction of tension and shear must be calculated in accordance with ACI 318-19 17.8, ACI 318-14 17.6 or ACI 318-11 D.7, as applicable.

4.1.9 Minimum Member Thickness, h_{min} , Anchor Spacing, s_{min} , and Edge Distance, c_{min} : In lieu of ACI 318-19 17.9.2, ACI 318-14 17.7.1 and 17.7.3 or ACI 318-11 D.8.1 and D.8.3, as applicable, values of s_{min} and c_{min} described in this report (Tables 8, 13, 18, 23, 28 and 33) must be observed for anchor design and installation. The minimum member thickness, h_{min} , described in this report (Tables 8, 13, 18, 23, 28 and 33) must be observed for anchor design and installation. For adhesive anchors that will remain untorqued, refer to ACI 318-19 17.9.3, ACI 318-14 17.7.4 or ACI 318-11 D.8.4, as applicable.

4.1.10 Critical Edge Distance c_{ac} and $\psi_{cp,Na}$: The modification factor $\psi_{cp,Na}$, must be determined in accordance with ACI 318-19 17.6.5.5, ACI 318-14 17.4.5.5 or ACI 318-11 D.5.5.5, as applicable, except as noted below:

For all cases where $c_{Na}/c_{ac} < 1.0$, $\psi_{cp,Na}$ determined from ACI 318-19 Eq. 17.6.5.5.1b, ACI 318-14 Eq. 17.4.5.5b or ACI 318-11 Eq. D-27, as applicable, need not be taken less than c_{Na}/c_{ac} . For all other cases, $\psi_{cp,Na}$ shall be taken as 1.0.

The critical edge distance, c_{ac} must be calculated according to Eq. 17.6.5.5.1c for ACI 318-19, Eq. 17.4.5.5c for ACI 318-14 or Eq. D-27a for ACI 318-11, in lieu of ACI 318-14 17.7.6 or ACI 318-11 D.8.6, as applicable.

$$c_{ac} = h_{ef} \left(\frac{\tau_{k,uncr}}{1160} \right)^{0.4} \left[3.1 - 0.7 \frac{h}{h_{ef}} \right]$$

(Eq. 17.6.5.5.1c for ACI 318-19, Eq. 17.4.5.5c for ACI 318-14 or Eq. D-27a for ACI 318-11)

where

$\left[\frac{h}{h_{ef}} \right]$ need not be taken as larger than 2.4; and

$\tau_{k,uncr}$ = the characteristic bond strength stated in the tables of this report whereby $\tau_{k,uncr}$ need not be taken as larger than:

$$\tau_{k,uncr} = \frac{k_{uncr} \sqrt{h_{ef} f'_c}}{\pi d_a} \quad \text{Eq. (4-1)}$$

4.1.11 Design Strength in Seismic Design Categories C, D, E and F: In structures assigned to Seismic Design Category C, D, E or F under the IBC or IRC, anchors must be designed in accordance with ACI 318-19 17.10, ACI 318-14 17.2.3 or 318-11 D.3.3, as applicable, except as described below.

The nominal steel shear strength, V_{sa} , must be adjusted by $\alpha_{V,seis}$ as given in Tables 7, 12, 17, 22, 27 and 32 of this report for the anchor element types included in this report. The nominal bond strength τ_{cr} must be adjusted by $\alpha_{N,seis}$ as noted in Tables 9 through 11, 14 through 16, 19 through 21, 24 through 26, 29 through 31, and 34 through 36 of this report.

As an exception to ACI 318-11 D.3.3.4.2: Anchors designed to resist wall out-of-plane forces with design strengths equal to or greater than the force determined in accordance with ASCE 7 Equation 12.11-1 or 12.14-10 shall be deemed to satisfy Section ACI 318-11 D.3.3.4.3(d).

Under ACI 318-11 D.3.3.4.3(d), in lieu of requiring the anchor design tensile strength to satisfy the tensile strength requirements of ACI 318-11 D.4.1.1, the anchor design tensile strength shall be calculated from ACI 318-11 D.3.3.4.4.

The following exceptions apply to ACI 318-11 D.3.3.5.2:

1. For the calculation of the in-plane shear strength of anchor bolts attaching wood sill plates of bearing or non-bearing walls of light-frame wood structures to foundations or foundation stem walls, the in-plane shear strength in accordance with ACI 318-11 D.6.2 and D.6.3 need not be computed and ACI 318-11 D.3.3.5.3 need not apply provided all of the following are satisfied:

1.1. The allowable in-plane shear strength of the anchor is determined in accordance with AF&PA NDS Table 11E for lateral design values parallel to grain.

1.2. The maximum anchor nominal diameter is $5/8$ inch (16 mm).

1.3. Anchor bolts are embedded into concrete a minimum of 7 inches (178 mm).

1.4. Anchor bolts are located a minimum of $1\ 3/4$ inches (45 mm) from the edge of the concrete parallel to the length of the wood sill plate.

1.5. Anchor bolts are located a minimum of 15 anchor diameters from the edge of the concrete perpendicular to the length of the wood sill plate.

1.6. The sill plate is 2-inch or 3-inch nominal thickness.

2. For the calculation of the in-plane shear strength of anchor bolts attaching cold-formed steel track of bearing or non-bearing walls of light-frame construction to foundations or foundation stem walls, the in-plane shear strength in accordance with ACI 318-11 D.6.2 and D.6.3 need not be computed and ACI 318-11 D.3.3.5.3 need not apply provided all of the following are satisfied:

2.1. The maximum anchor nominal diameter is $5/8$ inch (16 mm).

2.2. Anchors are embedded into concrete a minimum of 7 inches (178 mm).

2.3. Anchors are located a minimum of $1\ 3/4$ inches (45 mm) from the edge of the concrete parallel to the length of the track.

2.4. Anchors are located a minimum of 15 anchor diameters from the edge of the concrete perpendicular to the length of the track.

2.5. The track is 33 to 68 mil designation thickness.

Allowable in-plane shear strength of exempt anchors, parallel to the edge of concrete shall be permitted to be determined in accordance with AISI S100 Section E3.3.1.

3. In light-frame construction, bearing or nonbearing walls, shear strength of concrete anchors less than or equal to 1 inch [25 mm] in diameter attaching a sill plate or track to foundation or foundation stem wall need not satisfy ACI 318-11 D.3.3.5.3(a) through (c) when the design strength of the anchors is determined in accordance with ACI 318-11 D.6.2.1(c).

4.2 Strength Design of Post-Installed Reinforcing Bars:

4.2.1 General: The design of straight post-installed deformed reinforcing bars must be determined in accordance with ACI 318 rules for cast-in place reinforcing bar development and splices and this report.

Examples of typical applications for the use of post-installed reinforcing bars are illustrated in Figures 2 and 3 of this report.

4.2.2 Determination of bar development length l_d :

Values of l_d must be determined in accordance with the ACI 318 development and splice length requirements for straight cast-in place reinforcing bars.

Exceptions:

1. For uncoated and zinc-coated (galvanized) post-installed reinforcing bars, the factor Ψ_e shall be taken as 1.0. For all other cases, the requirements in ACI 318-19 25.4.2.5, ACI 318-14 25.4.2.4 or ACI 318-11 12.2.4 (b) shall apply.

2. When using alternate methods to calculate the development length (e.g., anchor theory), the applicable factors for post-installed anchors generally apply.

4.2.3 Minimum Member Thickness, h_{min} , Minimum Concrete Cover, $C_{c,min}$, Minimum Concrete Edge Distance, $c_{b,min}$, Minimum Spacing, $s_{b,min}$: For post-installed reinforcing bars, there is no limit on the minimum member thickness. In general, all requirements on concrete cover and spacing applicable to straight cast-in bars designed in accordance with ACI 318 shall be maintained.

For post-installed reinforcing bars installed at embedment depths, h_{ef} , larger than $20d_b$ ($h_{ef} > 20d_b$), the minimum concrete cover shall be as follows:

REBAR SIZE d_b	MINIMUM CONCRETE COVER $C_{c,min}$
$d_b \leq \#6$ (16 mm)	$1^{3/16}$ in. (30 mm)
$\#6 < d_b \leq \#11$ (16 mm $< d_b \leq 32$ mm)	$1^{9/16}$ in. (40 mm)

The following requirements apply for minimum concrete edge and spacing for $h_{ef} > 20d_b$:

Required minimum edge distance for post-installed reinforcing bars (measured from the center of the bar):

$$c_{b,min} = d_o/2 + C_{c,min}$$

Required minimum center-to-center spacing between post-installed bars:

$$s_{b,min} = d_o + C_{c,min}$$

Required minimum center-to-center spacing from existing (parallel) reinforcing:

$$s_{b,min} = d_b/2 \text{ (existing reinforcing)} + d_o/2 + C_{c,min}$$

All other requirements applicable to straight cast-in place bars designed in accordance with ACI 318 shall be maintained.

4.2.4 Design Strength in Seismic Design Categories C, D, E and F: In structures assigned to Seismic Category C, D, E or F under the IBC or IRC, design of straight post-installed reinforcing bars must take into account the provisions of ACI 318-19 or ACI 318-14 Chapter 18 or ACI 318-11 Chapter 21, as applicable

4.3 Installation:

Installation parameters are illustrated in Figures 1, 2 and 4 of this report. Installation must be in accordance with ACI 318-19 26.7.2, ACI 318-14 17.8.1 and 17.8.2 or ACI 318-11 D.9.1 and D.9.2, as applicable. Adhesive anchor locations must comply with this report and the plans and specifications approved by the code official. Installation of the fischer FIS EM Plus Adhesive Anchor System must conform to the manufacturer's printed installation instructions (MPII) included in each unit package as described in Figure 6 of this report.

The adhesive anchor system may be used for upwardly inclined orientation applications (e.g. overhead). Upwardly inclined, horizontal, and drill depths deeper than 10 inches (250 mm) and drill hole diameters larger than 1 1/2 inches (40 mm) are to be installed using injection adaptors in accordance with the MPII as shown in Figure 6 of this report. The injection adaptor corresponding to the hole diameter must be attached to the extension tubing and static mixer supplied by fischer.

4.4 Special Inspection:

4.4.1 General: Installations may be made under continuous special inspection or periodic special inspection, as determined by the registered design professional. Tables 9 through 11, 14 through 16, 19 through 21, 24 through 26, 29 through 31, and 34 through 36 of this report provide strength reduction factors, ϕ_{nn} , and strength modification factors, K_{nn} , corresponding to the type of inspection provided.

Continuous special inspection of adhesive anchors installed in horizontal or upwardly inclined orientations to resist sustained tension loads shall be performed in accordance with ACI 318-19 26.13.3.2(e), ACI 318-14 17.8.2.4, 26.7.1(h) and 26.13.3.2(c) or ACI 318-11 D.9.2.4, as applicable.

Under the IBC, additional requirements as set forth in Section 1705.1.1 and Table 1705.3 of the 2021, 2018, 2015, Or 2012 IBC and Sections 1705, 1706, or 1707 of the 2009 IBC must be observed, where applicable.

4.4.2 Continuous Special Inspection: Installations made under continuous special inspection with an on-site proof loading program must be performed in accordance with Section 1705.1.1 and Table 1705.3 of the 2021, 2018, 2015 and 2012 IBC, Section 1704.15 and Table 1704.4 of the 2009 IBC, whereby continuous special inspection is defined in Section 1702.1 of the IBC, and this report. The special inspector must be on the jobsite continuously during anchor installation to verify anchor type, adhesive expiration date, anchor dimensions, concrete type, concrete compressive strength, hole dimensions, hole cleaning procedures, anchor spacing, edge distances, concrete thickness, anchor embedment, tightening torque, and adherence to the manufacturer's printed installation instructions.

The proof loading program must be established by the registered design professional. As a minimum, the following requirements must be addressed in the proof loading program:

1. Frequency of proof loading based on anchor type, diameter, and embedment.
2. Proof loads by anchor type, diameter, embedment, and location.
3. Acceptable displacements at proof load.
4. Remedial action in the event of a failure to achieve proof load, or excessive displacement.

Unless otherwise directed by the registered design professional, proof loads must be applied as confined tension tests. Proof load levels must not exceed the lesser of 67 percent of the load corresponding to the nominal bond strength as calculated from the characteristic bond stress for uncracked concrete modified for edge effects and concrete properties, or 80 percent of the minimum specified anchor element yield strength ($A_{se,N} \cdot f_{ya}$). The proof load must be maintained at the required load level for a minimum of 10 seconds.

4.4.3 Periodic Special Inspection: Periodic special inspection must be performed where required in accordance with Sections 1705.1.1 and Table 1705.3 of the 2021, 2018, 2015 and 2012 IBC, or Table 1704.4 and Section 1704.15 of the 2009 IBC and this report. The special inspector must be on the jobsite initially during anchor installation to verify anchor type, anchor dimensions, concrete type, concrete compressive strength, adhesive identification and expiration date, hole dimensions, hole cleaning procedures, anchor spacing, edge distances, concrete thickness, anchor embedment, tightening torque and adherence to the manufacturer's published installation instructions.

The special inspector must verify the initial installations of each type and size of adhesive anchor by construction personnel on site. Subsequent installations of the same anchor type and size by the same construction personnel are permitted to be performed in the absence of the special inspector. Any change in the anchor product being installed or the personnel performing the installation requires an initial inspection. For ongoing installations over an extended period, the special inspector must make regular inspections to confirm correct handling and installation of the product.

5.0 CONDITIONS OF USE

The fischer FIS EM Plus Adhesive Anchor System and Post-Installed Reinforcing Bar System described in this report is a suitable alternative to what is specified in the codes listed in Section 1.0 of this report, subject to the following conditions:

- 5.1 fischer FIS EM Plus adhesive anchors and post-installed reinforcing bars must be installed in accordance with this report and the manufacturer's printed installation instructions included in the adhesive packaging and described in Figure 6 of this report.
- 5.2 The anchors and post-installed reinforcing bars must be installed in cracked or uncracked normal-weight concrete having a specified compressive strength $f'_c = 2,500$ psi to 8,500 psi (17.2 MPa to 58.6 MPa) [minimum of 24 MPa is required under ADIBC Appendix L, Section 5.1.1].
- 5.3 The values of f'_c used for calculation purposes must not exceed 8,000 psi (55 MPa).
- 5.4 Anchors and post-installed reinforcing bars must be installed in concrete base materials in holes predrilled in accordance with the instructions provided in Figure 6 of this report.
- 5.5 Loads applied to the anchors must be adjusted in accordance with Section 1605.1 of the 2021 IBC, Section 1605.2 of the 2018, 2015, 2012 and 2009 IBC for strength design.
- 5.6 fischer FIS EM Plus adhesive anchors are recognized for use to resist short- and long-term loads, including wind and earthquake loads, subject to the conditions of this report.
- 5.7 In structures assigned to Seismic Design Category C, D, E or F under the IBC or IRC, anchor strength must be adjusted in accordance with Section 4.1.11 of this report.
- 5.8 fischer FIS EM Plus adhesive anchors and post-installed reinforcing bars are permitted to be installed in concrete that is cracked or that may be expected to crack during the service life of the anchor, subject to the conditions of this report.
- 5.9 Strength design values are established in accordance with Section 4.1 of this report.
- 5.10 Post-installed reinforcing bar development and splice length is established in accordance with Section 4.2 of this report.
- 5.11 Minimum anchor spacing and edge distance, as well as minimum member thickness, must comply with the values given in this report.
- 5.12 Post-installed reinforcing bar spacing, minimum member thickness, and cover distance must be in accordance with the provisions of ACI 318 for cast-in place bars and section 4.2.3 of this report.
- 5.13 Prior to installation, calculations and details demonstrating compliance with this report must be submitted to the code official. The calculations and details must be prepared by a registered design professional where required by the statutes of the jurisdiction in which the project is to be constructed.
- 5.14 The fischer FIS EM Plus Adhesive Anchoring System and Post-Installed Reinforcing Bar System are not permitted to support fire-resistive construction. Where not otherwise prohibited by the code, the fischer FIS EM Plus Adhesive Anchoring System and Post-Installed Reinforcing Bar System are permitted for installation in fire-resistive construction provided that at least one of the following conditions is fulfilled:
 - Anchors and post-installed reinforcing bars are used to resist wind or seismic forces only.
 - Anchors and post-installed reinforcing bars that support gravity load-bearing structural elements are within a fire-resistive envelope or a fire-resistive membrane, are protected by approved fire-resistive materials, or have been evaluated for resistance to fire exposure in accordance with recognized standards.
 - Anchors and post-installed reinforcing bars are used to support nonstructural elements.
- 5.15 Since an ICC-ES acceptance criteria for evaluating data to determine the performance of adhesive anchors subjected to fatigue or shock loading is unavailable at this time, the use of these anchors under such conditions is beyond the scope of this report.
- 5.16 Use of zinc-plated carbon steel threaded rods or steel reinforcing bars is limited to dry, interior locations.
- 5.17 Use of hot-dipped galvanized carbon steel and stainless steel rods is permitted for exterior exposure or damp environments.

- 5.18** Steel anchoring materials in contact with preservative-treated and fire-retardant-treated wood must be of zinc-coated carbon steel or stainless steel. The minimum coating weights for zinc-coated steel must comply with ASTM A153.
- 5.19** Special inspection must be provided in accordance with Section 4.4 of this report. Continuous special inspection for anchors installed in horizontal or upwardly inclined orientations resist sustained tension loads must be provided in accordance with Section 4.4 of this report.
- 5.20** Installation of anchors in horizontal or upwardly inclined orientations to resist sustained tension loads shall be performed by personnel certified by an applicable certification program in accordance with ACI 318-19 26.7.2(e), ACI 318-14 17.8.2.2 or 17.8.2.3 or ACI 318-11 D.9.2.2 or D.9.2.3, as applicable.
- 5.21** fischer FIS EM Plus adhesive anchors and post-installed reinforcing bars may be used to resist tension and shear forces in floor, wall, and overhead installations only if installation is into concrete with a temperature between 23°F and 104°F (-5°C and 40°C) for threaded rods, rebar, and internal threaded anchors. For overhead installations and applications between horizontal and overhead use the appropriate injection adapter and at least three wedges or the fischer overhead clip to the anchor during curing time [the minimum cartridge temperature of 41 °F (5 °C) must be ensured]. Also use an injection adapter for all applications with a drill hole depth $h_0 > 10$ inches (>250 mm) or a drill hole diameter $d_0 \geq 1\frac{1}{2}$ inches (≥ 40 mm). Use appropriate accessories to capture excess adhesive during installation of the anchor element in order to protect the unbonded portion of the anchor element from adhesive.
- 5.22** Anchors and post-installed reinforcing bars shall not be used for installations where the concrete temperature can rise from 40°F (or less) to 80°F (or higher) within a 12-hour period. Such applications may include but are not limited to anchorage of building facade systems and other applications subject to direct sun exposure.
- 5.23** fischer FIS EM Plus adhesive is manufactured by fischerwerke GmbH & Co. KG, Denzlingen, Germany, under a quality-control program with inspections by ICC-ES.

6.0 EVIDENCE SUBMITTED

Data in accordance with the ICC-ES Acceptance Criteria for Post-Installed Adhesive Anchors in Concrete Elements (AC308), dated June 2019 (editorially revised February 2021).

7.0 IDENTIFICATION

- 7.1** fischer FIS EM Plus adhesive is identified by packaging labeled with the manufacturer's name (fischerwerke) and address, product name, lot number, expiration date, and the evaluation report number (ESR-1990).
- 7.2** fischer internal threaded anchors RG M I are identified by packaging labeled with the manufacturer's name (fischerwerke) and address, product name and size, and the evaluation report number (ESR-1990). fischer threaded rods FIS A and RG M are identified by packaging labeled with the manufacturer's name (fischerwerke) and address, product name and size, and the evaluation report number (ESR-1990). Threaded rods, nuts, washers and deformed reinforcing bars are standard elements and must conform to applicable national or international specifications as set forth in Tables 2, 3, and 4 of this report.
- 7.3** The report holder's contact information is the following:

fischerwerke GmbH & Co. KG
KLAUS-FISCHER-STRASSE 1
72178 WALDACHTAL
GERMANY
+49 7443 120
www.fischer-international.com

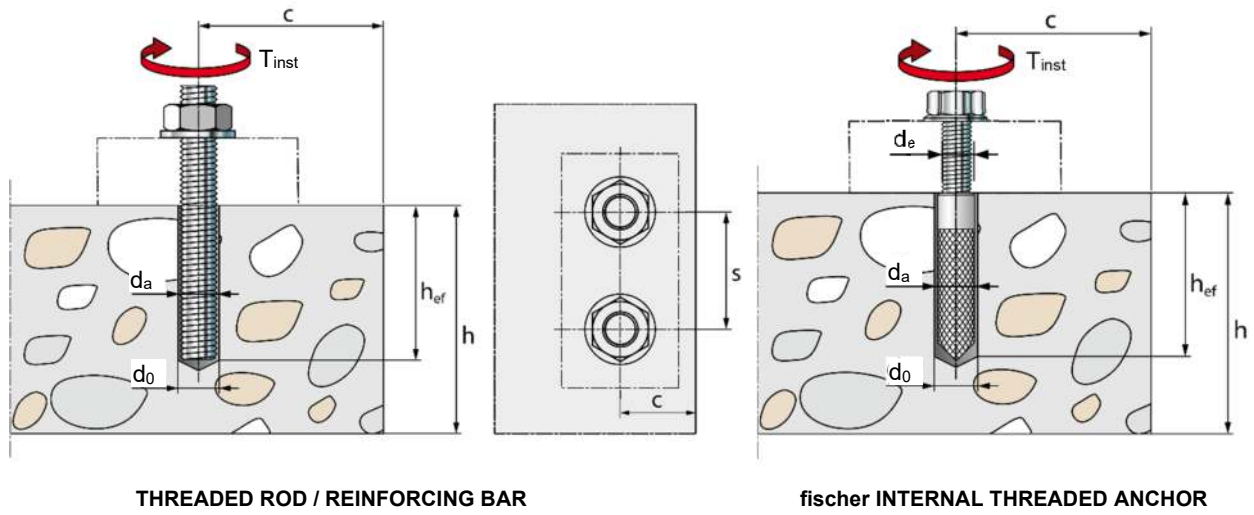

THREADED ROD / REINFORCING BAR

fischer INTERNAL THREADED ANCHOR

FIGURE 1—GENERAL INSTALLATION PARAMETERS FOR THREADED RODS, REINFORCING BARS AND INTERNAL THREADED ANCHORS

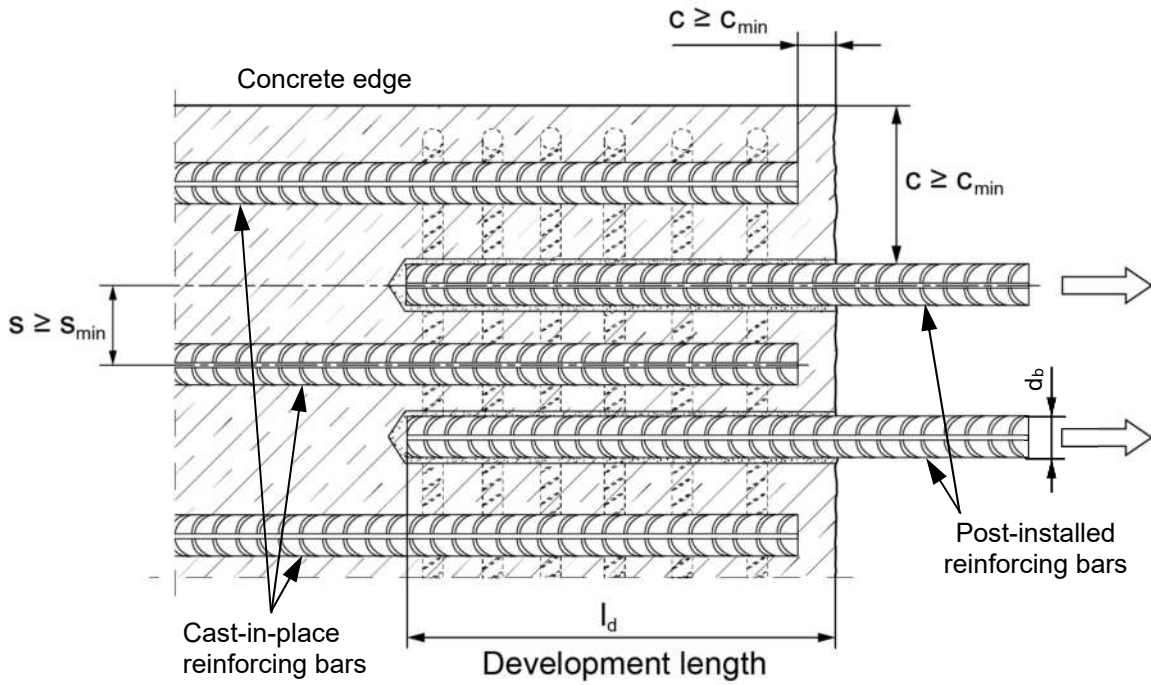
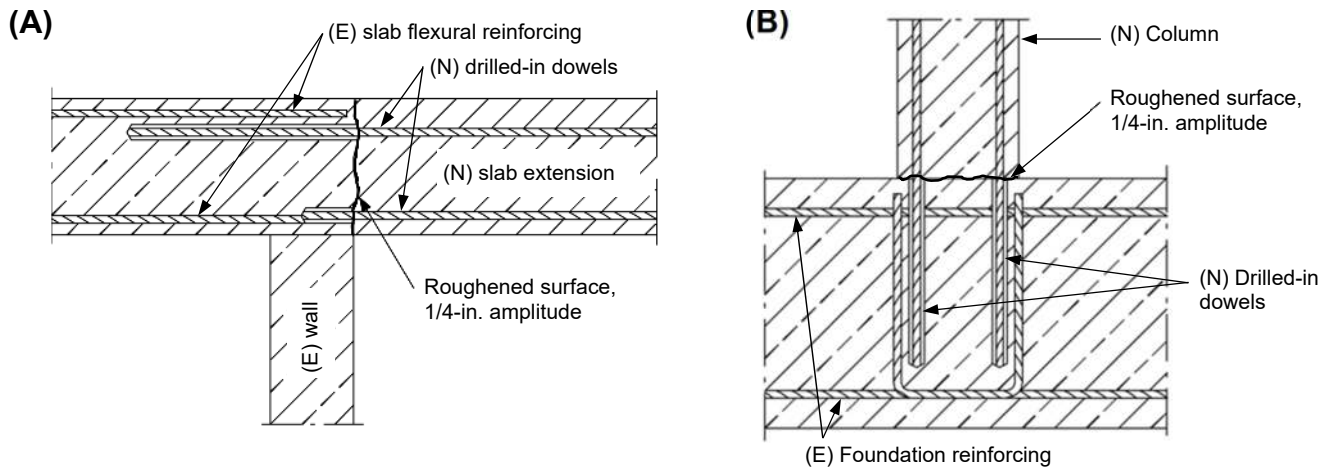
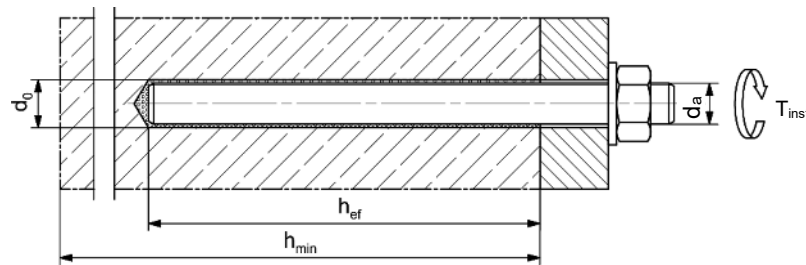

FIGURE 2—GENERAL INSTALLATION PARAMETERS FOR POST-INSTALLED REINFORCING BARS



**FIGURE 3—(A) OVERLAP JOINT WITH EXISTING REINFORCEMENT FOR REBAR CONNECTIONS
(B) OVERLAP JOINT WITH EXISTING REINFORCEMENT AT A FOUNDATION OF A COLUMN OR WALL**



METRIC THREADED RODS

$\varnothing d_a$ [mm]	$\varnothing d_0$ [mm]	$h_{ef,min}$ [mm]	$h_{ef,max}$ [mm]	h_{min} [mm]	T_{inst} [Nm]
M8	10	60	160	100	10
M10	12	60	200	100	20
M12	14	70	240	100	40
M16	18	80	320	116	60
M20	24	90	400	138	120
M24	28	96	480	152	150
M27	30	108	540	162	200
M30	35	120	600	190	300

FRACTIONAL THREADED RODS

$\varnothing d_a$ [inch]	$\varnothing d_0$ [inch]	$h_{ef,min}$ [inch]	$h_{ef,max}$ [inch]	h_{min} [inch]	T_{inst} [ft · lb]
$\frac{3}{8}$	$\frac{7}{16}$	$2 \frac{3}{8}$	$7 \frac{1}{2}$	$3 \frac{5}{8}$	15
$\frac{1}{2}$	$\frac{9}{16}$	$2 \frac{3}{4}$	10	$3 \frac{5}{8}$	30
$\frac{5}{8}$	$\frac{3}{4}$	$3 \frac{1}{8}$	$12 \frac{1}{2}$	$4 \frac{5}{8}$	50
$\frac{3}{4}$	$\frac{7}{8}$	$3 \frac{1}{2}$	15	$5 \frac{1}{4}$	90
$\frac{7}{8}$	1	$3 \frac{1}{2}$	$17 \frac{1}{2}$	$5 \frac{1}{2}$	100
1	$1 \frac{1}{8}$	4	20	$6 \frac{1}{4}$	135
$1 \frac{1}{8}$	$1 \frac{1}{4}$	$4 \frac{1}{2}$	$22 \frac{1}{2}$	7	180
$1 \frac{1}{4}$	$1 \frac{3}{8}$	5	25	$7 \frac{3}{4}$	240

FIGURE 4—INSTALLATION PARAMETERS

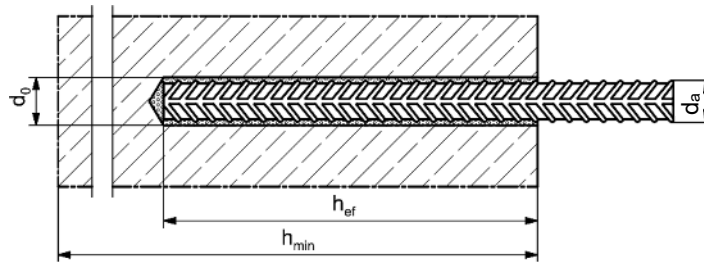

COMMON STEEL REINFORCING BARS

$\varnothing d_a$ [mm]	$\varnothing d_0$ [mm]	$h_{ef,min}$ [mm]	$h_{ef,max}$ [mm]	h_{min} [mm]	T_{inst} [Nm]
10	14	60	200	100	30
12	16	70	240	102	50
16	20	80	320	116	110
20	25	90	400	130	190
25	30	100	500	150	280
28	35	112	560	168	350
32	40	128	640	192	430

FRACTIONAL REINFORCING BARS

$\varnothing d_a$ [inch]	$\varnothing d_0$ [inch]	$h_{ef,min}$ [inch]	$h_{ef,max}$ [inch]	h_{min} [inch]	T_{inst} [ft · lb]
#3	$\frac{1}{2}$	$2 \frac{3}{8}$	$7 \frac{1}{2}$	$3 \frac{5}{8}$	22
#4	$\frac{5}{8}$	$2 \frac{3}{4}$	10	4	44
#5	$\frac{13}{16}$	$3 \frac{1}{8}$	$12 \frac{1}{2}$	$4 \frac{1}{8}$	81
#6	$\frac{7}{8}$	$3 \frac{1}{2}$	15	$5 \frac{1}{4}$	129
#7	$1 \frac{1}{8}$	$3 \frac{1}{2}$	$17 \frac{1}{2}$	$5 \frac{3}{4}$	177
#8	$1 \frac{1}{4}$	4	20	$6 \frac{1}{2}$	236
#9	$1 \frac{3}{8}$	$4 \frac{1}{2}$	$22 \frac{1}{2}$	$7 \frac{1}{4}$	280
#10	$1 \frac{1}{2}$	5	25	8	332
#11	$1 \frac{3}{4}$	$5 \frac{1}{2}$	$27 \frac{1}{2}$	9	332

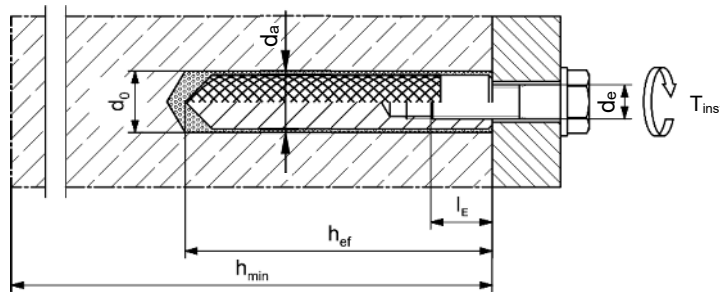

METRIC Fischer INTERNAL THREADED ANCHOR

$\varnothing d_e$ [mm]	$\varnothing d_0$ [mm]	$\varnothing d_a$ [mm]	h_{ef} [mm]	h_{min} [mm]	T_{inst} [Nm]
M8	14	12	90	120	10
M10	18	16	90	125	20
M12	20	18	125	165	40
M16	24	22	160	205	80
M20	32	28	200	260	120

FRACTIONAL Fischer INTERNAL THREADED ANCHOR

$\varnothing d_e$ [inch]	$\varnothing d_0$ [inch]	$\varnothing d_a$ [inch]	h_{ef} [inch]	h_{min} [inch]	T_{inst} [ft · lb]
$\frac{3}{8}$	$\frac{3}{4}$	$\frac{5}{8}$	3.54	4.92	15
$\frac{1}{2}$	$\frac{13}{16}$	$\frac{11}{16}$	4.92	6.50	30
$\frac{5}{8}$	1	$\frac{7}{8}$	6.30	8.07	59
$\frac{3}{4}$	$1 \frac{1}{4}$	$1 \frac{1}{8}$	7.87	10.24	89

FIGURE 4—INSTALLATION PARAMETERS (CONTINUED)

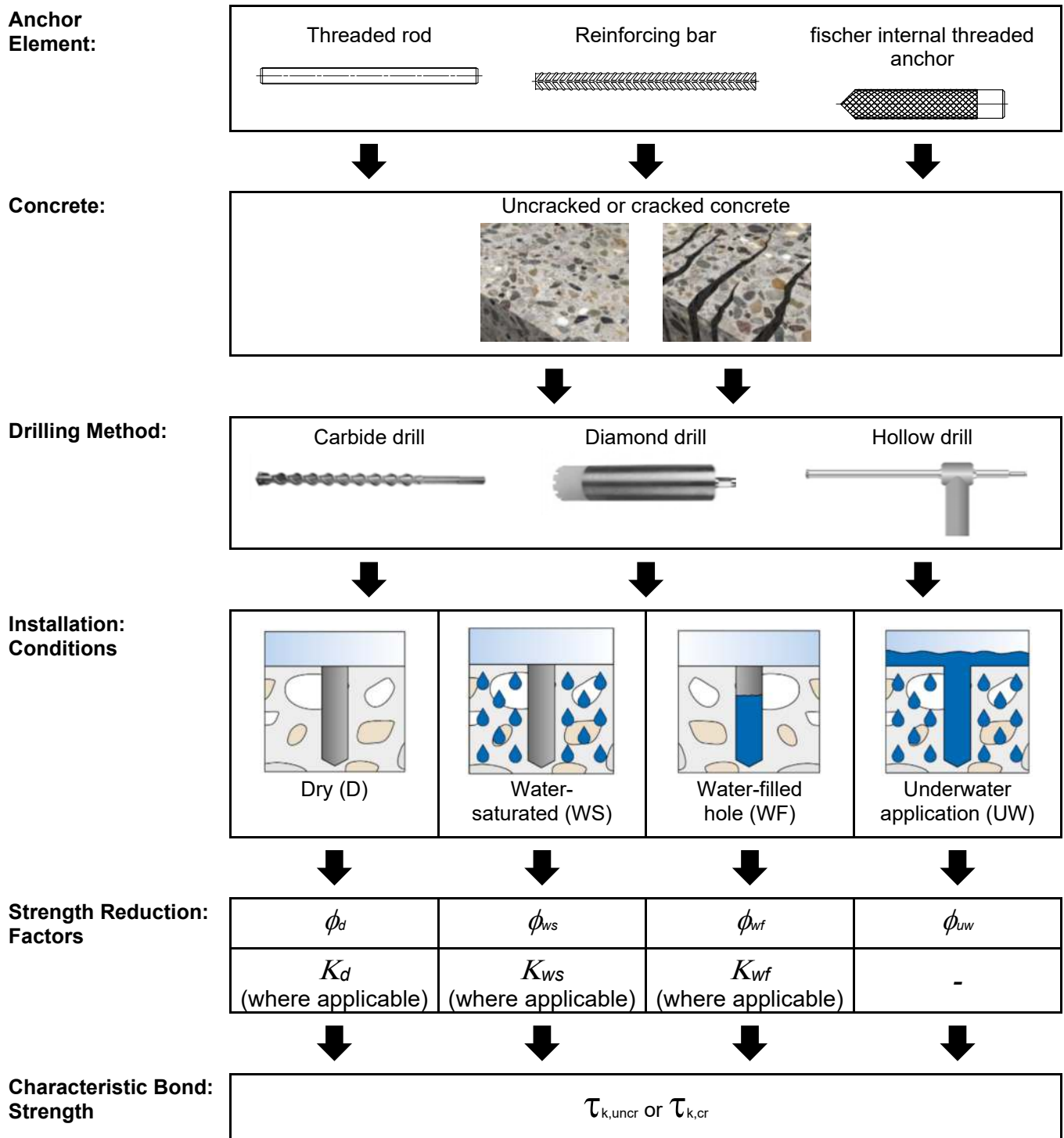

FIGURE 5—FLOWCHART FOR THE DETERMINATION OF THE DESIGN BOND STRENGTH

TABLE 1—DESIGN TABLE INDEX

Design strength ¹		Threaded rod		Deformed reinforcement		Internal threaded anchor	
		Metric	Fractional	Metric	Fractional	Metric	Fractional
Steel	N_{sa}, V_{sa}	Table 7	Table 22	Table 12	Table 27	Table 17	Table 32
Concrete	$N_{cb}, N_{cbg}, V_{cb}, V_{cbg}, V_{cp}, V_{cpb}$	Table 8	Table 23	Table 13	Table 28	Table 18	Table 33
Bond ²	N_a, N_{ag}	Table 9 to 11	Table 24 to 26	Table 14 to 16	Table 29 to 31	Table 19 to 21	Table 34 to 36
Bond reduction factors	$\phi_d, \phi_{ws}, \phi_{wf}, \phi_{uw}, K_d, K_{ws}, K_{wf}$	Table 9 to 11	Table 24 to 26	Table 14 to 16	Table 29 to 31	Table 19 to 21	Table 34 to 36

¹Design strengths are as set forth in ACI 318-19 17.5.1.2, ACI 318-14 17.3.1.1 or ACI 318-11 D.4.1.1, as applicable.

²See Section 4.1 of this report for bond strength information.

TABLE 2—SPECIFICATIONS AND PHYSICAL PROPERTIES OF COMMON CARBON STEEL THREADED ROD MATERIALS AND FISCHER THREADED RODS FIS A AND RG M¹

THREADED ROD SPECIFICATION		Minimum specified ultimate strength (f_{uta})	Minimum specified yield strength 0.2% offset (f_{ya})	f_{uta}/f_{ya}	Elongation, min. (percent) ⁷	Reduction of Area, min. (percent)	Specification for nuts ⁹
							
ASTM F568M ³ Class 5.8 (equivalent to ISO 898-1 ² Class 5.8)	MPa (psi)	500 (72,519)	400 (58,015)	1.25	10 ⁸	35	DIN 934 Grade 6 (8-A2K) (Metric) ASTM A563 Grade DH
ISO 898-1 ² Class 8.8	MPa (psi)	800 (116,030)	640 (92,824)	1.25	12 ⁸	52	DIN 934 Grade 8 (8-A2K)
ASTM A36 ⁴ and F1554 ⁵ Grade 36	MPa (psi)	400 (58,000)	248 (36,000)	1.61	23	40	ASTM A194 / A563 Grade A
ASTM F1554 ⁵ Grade 55	MPa (psi)	517 (75,000)	380 (55,000)	1.36	23	40	
ASTM A193 ⁶ Grade B7 ≤ 2 1/2 in. (≤64mm)	MPa (psi)	862 (125,000)	724 (105,000)	1.19	16	50	ASTM A194 / A563 Grade DH
ASTM F1554 ⁵ Grade 105	MPa (psi)	862 (125,000)	724 (105,000)	1.19	15	45	

¹fischer FIS EM Plus must be used with continuously threaded carbon steel rod (all-thread) that have thread characteristics comparable with ANSI B1.1 UNC Coarse Thread Series or ANSI B1.13M M Profile Metric Thread Series.

²Mechanical properties of fasteners made of carbon steel and alloy steel – Part 1: Bolts, screws and studs.

³Standard Specification for Carbon and Alloy Steel Externally Threaded Metric Fasteners.

⁴Standard Specification for Carbon Structural Steel.

⁵Standard Specification for Anchor Bolts, Steel, 36, 55 and 105ksi Yield Strength.

⁶Standard Specification for Alloy Steel and Stainless Steel Bolting Materials for High Temperature Service.

⁷Based on 2-in. (50 mm) gauge length except ISO 898, which is based on 5d.

⁸≥14 % for fischer FIS A and RG M.

⁹Nuts of other grades and styles having specified proof load stresses greater than the specified grade and style are also suitable. Nuts must have specified proof load stresses equal or greater than the minimum tensile strength of the specific threaded rods.

TABLE 3—SPECIFICATIONS AND PHYSICAL PROPERTIES OF COMMON STAINLESS STEEL THREADED ROD MATERIALS AND FISCHER THREADED RODS FIS A AND RG M¹

THREADED ROD SPECIFICATION			Minimum specified ultimate strength (f_{uta})	Minimum specified yield strength 0.2% offset (f_{ya})	f_{uta}/f_{ya}	Elongation, min. (percent)	Reduction of Area, min. (percent)	Specification for nuts ⁶
	ISO 3056-1 ² A4-80 and fischer FIS A / RGM Type R and HCR Grade 80 M8-M30	MPa (psi)	800 (116,000)	600 (87,000)	1.34	12 ⁶	- ⁷	ISO 4032
	ISO 3506-1 ² A4-70 and fischer FIS A / RGM Type R and HCR Grade 70 M8-M30	MPa (psi)	700 (101,500)	450 (65,250)	1.56	16	- ⁷	ISO 4032
ASTM F593 ³ CW1 (316) ¹ / ₄ to ⁵ / ₈ in.	MPa (psi)	689 (100,000)	448 (65,000)	1.54	20	-	ASTM F594 Alloy group 1, 2, 3	
ASTM F593 ³ CW2 (316) ³ / ₄ to 1 ¹ / ₂ in.	MPa (psi)	586 (85,000)	310 (45,000)	1.89	25	-		
ASTM A193 ⁴ Grad B8/B8M, Class 1	MPa (psi)	517 (75,000)	207 (30,000)	2.50	30	50	ASTM F594 Alloy Group 1, 2 or 3	
ASTM A193 ⁴ Grad B8/B8M, Class 2B	MPa (psi)	655 (95,000)	517 (75,000)	1.27	25	40		

¹fischer FIS EM Plus may be used with continuously threaded stainless steel rod (all-thread) with thread characteristics comparable with ANSI B1.1 UNC Coarse Thread Series or ANSI B1.13M M Profile Metric Thread Series.

²Mechanical properties of corrosion resistant stainless steel fasteners – Part 1: Bolts, screws and studs

³Standard Steel Specification for Stainless Steel Bolts, Hex Cap Screws and Studs.

⁴Standard Specification for Alloy Steel and Stainless Steel Bolting Materials for High Temperature Service.

⁵Based on 2-in. (50 mm) gauge length except ISO 898, which is based on 5d.

⁶≥14 % for fischer FIS A and RG M.

⁷≥30 % for fischer FIS A and RG M.

⁸Nuts of other grades and styles having specified proof load stresses greater than the specified grade and style are also suitable. Nuts must have specified proof load stresses equal or greater than the minimum tensile strength of the specific threaded rods. Material types of the nuts and washers must be matched to the threaded rods.

TABLE 4—SPECIFICATIONS AND PHYSICAL PROPERTIES OF COMMON STEEL REINFORCING BARS

REINFORCING BAR SPECIFICATION		Minimum specified ultimate strength (f_{uta})	Minimum specified yield strength (f_{ya})	
	DIN 488 B500B ¹	MPa (psi)	540 (78,300)	500 (72,500)
	ASTM A615 ² , ASTM A767 ³ Gr. 40	MPa (psi)	414 (60,000)	276 (40,000)
ASTM A615 ² , ASTM A767 ³ Gr. 60	MPa (psi)	621 (90,000)	414 (60,000)	
ASTM A706 ⁴ , ASTM A767 ³ Gr. 60	MPa (psi)	552 (80,000)	414 (60,000)	

¹Reinforcing steel; reinforcing steel bars; dimensions and masses.

²Standard Specification for Deformed and Plain Carbon Steel Bars for Concrete Reinforcement.

³Standard Specification for Zinc-Coated (Galvanized) Steel Bars for Concrete Reinforcement.

⁴Billet Steel Bars for Concrete Reinforcement.

TABLE 5—SPECIFICATIONS AND PHYSICAL PROPERTIES OF FISCHER INTERNAL THREADED ANCHOR RG M I

fischer INTERNAL THREADED ANCHOR RG M I SPECIFICATION 		Minimum specified ultimate strength (f_{uta})	Minimum specified yield strength (f_{ya})	f_{uta}/f_{ya}
ASTM F568M ¹ Grade 5.8 ³ (equivalent to ISO 898-1 ² Grade 5.8)	MPa (psi)	525 (76,150)	420 (60,900)	1.25
ISO 3506-1 A4-70 ⁴ (fischer RG M I Type R and HCR)	MPa (psi)	700 (101,550)	450 (65,250)	1.56

¹Standard Specification for Carbon and Alloy Steel Externally Threaded Metric Fasteners.

²Mechanical properties of fasteners made of carbon steel and alloy steel – Part 1: Bolts, screws and studs.

³Minimum Grade 5 bolts, cap screws or studs must be used with carbon steel RG M I internal threaded anchor.

⁴Only stainless steel bolts, cap screws or studs must be used with RG M I Type R and HCR.

TABLE 6—SPECIFICATIONS AND PHYSICAL PROPERTIES OF COMMON BOLTS, CAP SCREWS AND STUDS FOR USE WITH FISCHER INTERNAL THREADED ANCHOR RG M I

BOLT CAP SCREW OR STUD SPECIFICATION 		Minimum specified ultimate strength (f_{uta})	Minimum specified yield strength (f_{ya})	f_{uta}/f_{ya}	Elongation, min. (percent)	Reduction of Area, min. (percent)	Specifications for Nuts ³
ASTM F568M ¹ Grade 5.8 (equivalent to ISO 898-1 ² Grade 5.8)	MPa (psi)	(500) 72,500	(400) 58,000	1.25	14	30	EN ISO 898-2 Grade 5
ISO 898-1 Grade 8.8	MPa (psi)	(800) 116,000	(640) 92,800	1.25	14	30	EN ISO 898-2 Grade 8
ISO 3506-1 Grade A4-70	MPa (psi)	(700) 101,550	(450) 65,250	1.56	14	30	EN ISO 3506-2 Grade A4-70 ⁴

¹Standard Specification for Carbon and Alloy Steel Externally Threaded Metric Fasteners.

²Mechanical properties of fasteners made of carbon steel and alloy steel – Part 1: Bolts, screws and studs.

³Nuts must have specified minimum proof load stress equal to or greater than the specified minimum full-size tensile strength of the specified stud

⁴Nuts for Stainless steel studs must be of the same Alloy group as the specified bolt, cap screw or stud

TABLE 7—STEEL DESIGN INFORMATION FOR METRIC THREADED ROD¹

DESIGN INFORMATION		SYMBOL	UNITS	NOMINAL ROD DIAMETER (mm)							
				M8	M10	M12	M16	M20	M24	M27	M30
Rod Outside Diameter		d_a	mm (in.)	8 (0.31)	10 (0.39)	12 (0.47)	16 (0.63)	20 (0.79)	24 (0.94)	27 (1.06)	30 (1.18)
Rod effective cross-sectional area		A_{se}	mm ² (in. ²)	36.6 (0.057)	58.0 (0.090)	84.3 (0.131)	156.7 (0.243)	244.8 (0.379)	352.5 (0.546)	459.4 (0.712)	560.7 (0.869)
ISO 898-1 Grade 5.8	Nominal strength as governed by steel strength	N_{sa}	kN (lb)	18.3 (4,115)	29.0 (6,520)	42.2 (9,475)	78.4 (17,615)	122.4 (27,515)	176.3 (39,625)	229.7 (51,640)	280.4 (63,025)
		V_{sa}	kN (lb)	11.0 (2,470)	17.4 (3,910)	25.3 (5,685)	47.0 (10,570)	73.4 (16,510)	105.8 (23,775)	137.8 (30,985)	168.2 (37,815)
	Reduction for seismic shear	$\alpha_{V,seis}$	-	1.0					0.87		
	Strength reduction factor ϕ for tension ²	ϕ	-	0.65 ³ / 0.75 ⁴							
	Strength reduction factor ϕ for shear ²	ϕ	-	0.60 ³ / 0.65 ⁴							
	ISO 898-1 Grade 8.8	Nominal strength as governed by steel strength	N_{sa}	kN (lb)	29.3 (6,580)	46.4 (10,430)	67.4 (15,160)	125.4 (28,180)	195.8 (44,025)	282.0 (63,395)	367.5 (82,620)
V_{sa}			kN (lb)	17.6 (3,950)	27.8 (6,260)	40.5 (9,095)	75.2 (16,910)	117.5 (26,415)	169.2 (38,040)	220.5 (49,575)	269.1 (60,505)
Reduction for seismic shear		$\alpha_{V,seis}$	-	0.90							
Strength reduction factor ϕ for tension ²		ϕ	-	0.65 ³ / 0.75 ⁴							
Strength reduction factor ϕ for shear ²		ϕ	-	0.60 ³ / 0.65 ⁴							
ISO 3506-1 Grade 70 and stainless HCR 70	Nominal strength as governed by steel strength	N_{sa}	kN (lb)	25.6 (5,760)	40.6 (9,125)	59.0 (13,265)	109.7 (24,660)	171.4 (38,525)	246.8 (55,470)	321.6 (72,295)	392.5 (88,235)
		V_{sa}	kN (lb)	15.4 (3,455)	24.4 (5,475)	35.4 (7,960)	65.8 (14,795)	102.8 (23,115)	148.1 (33,285)	192.9 (43,375)	235.5 (52,940)
	Reduction for seismic shear	$\alpha_{V,seis}$	-	0.90							
	Strength reduction factor ϕ for tension ²	ϕ	-	0.65 ³ / 0.75 ⁴							
	Strength reduction factor ϕ for shear ²	ϕ	-	0.60 ³ / 0.65 ⁴							
ISO 3506-1 Grade 80 and stainless HCR 80	Nominal strength as governed by steel strength	N_{sa}	kN (lb)	29.3 (6,580)	46.4 (10,430)	67.4 (15,160)	125.4 (28,180)	195.8 (44,025)	282.0 (63,395)	367.5 (82,620)	448.6 (100,840)
		V_{sa}	kN (lb)	17.6 (3,950)	27.8 (6,260)	40.5 (9,095)	75.2 (16,910)	117.5 (26,415)	169.2 (38,040)	220.5 (49,575)	269.1 (60,505)
	Reduction for seismic shear	$\alpha_{V,seis}$	-	0.90							
	Strength reduction factor ϕ for tension ²	ϕ	-	0.65 ³ / 0.75 ⁴							
	Strength reduction factor ϕ for shear ²	ϕ	-	0.60 ³ / 0.65 ⁴							

For SI: 1 inch = 25.4 mm, 1lbf = 4.448 N, 1 psi = 0.006897 MPa.

For pound-inch units: 1 mm = 0.03937 inch, 1 N = 0.2248 lbf, 1MPa = 145.0 psi.

¹Values provided for common rod material types are based on specified strength and calculated in accordance with ACI 318-19 Eq. 17.6.1.2, ACI 318-14 Eq. 17.4.1.2 and Eq. 17.5.1.2b or ACI 318-11 Eq. D-2 and Eq. D-29, as applicable. Nuts and washers must be appropriate for the rod strength and type.

²For use with load combinations, Section 1605.1 of the 2021 IBC, Section 1605.2 of the 2018, 2015, 2012 and 2009 IBC, ACI 318-19 and ACI 318-14 5.3 or ACI 318-11 9.2, as applicable, as set forth in ACI 318-19 17.5.3, ACI 318-14 17.3.3 or ACI 318-11 D.4.3, as applicable. If the load combinations of ACI 318-11 Appendix C are used, the appropriate value of ϕ must be determined in accordance with ACI 318-11 D.4.4. Values correspond to a brittle steel element.

³Values correspond to a brittle steel element, applicable for standard threaded rods.

⁴Values correspond to a ductile steel element, applicable for fischer FIS A and RG M threaded rods only.

TABLE 8—CONCRETE BREAKOUT DESIGN INFORMATION FOR METRIC THREADED ROD

DESIGN INFORMATION		SYMBOL	UNITS	THREADED ROD DIAMETER (mm)							
				8	10	12	16	20	24	27	30
Embedment Depth	Minimum	$h_{ef,min}$	mm (in.)	60 (2.36)	60 (2.36)	70 (2.76)	80 (3.15)	90 (3.54)	96 (3.78)	108 (4.25)	120 (4.72)
	Maximum	$h_{ef,max}$	mm (in.)	160 (6.30)	200 (7.87)	240 (9.45)	320 (12.60)	400 (15.75)	480 (18.90)	540 (21.26)	600 (23.62)
Effectiveness Factor	Uncracked Concrete	$k_{c,uncr}$	SI (in.lb)	10 (24)							
	Cracked Concrete	$k_{c,cr}$	SI (in.lb)	7.1 (17)							
Minimum Value	Anchor Spacing	s_{min}	mm / (in.)	$s_{min} = c_{min}$							
	Edge Distance	c_{min}	mm (in.)	40 (1.57)	45 (1.77)	55 (2.17)	65 (2.56)	85 (3.35)	105 (4.13)	120 (4.72)	140 (5.51)
	Member Thickness	h_{min}	mm (in.)	$h_{ef} + 30 (\geq 100)$ $(h_{ef} + 1.25 \geq 4)$			$h_{ef} + 2d_o^1$				
Critical Value	Edge Distance for Splitting Failure	c_{ac}	mm (in.)	See Section 4.1.10 of this report.							
Strength reduction factor ϕ , concrete failure modes, Condition B ²	Tension	ϕ	-	0.65							
	Shear	ϕ	-	0.70							

For SI: 1 inch = 25.4 mm, 1lbf = 4.448 N, 1 psi = 0.006897 MPa.

For pound-inch units: 1 mm = 0.03937 inch, 1 N = 0.2248 lbf, 1MPa = 145.0 psi.

¹ d_o = drill hole diameter

²Values provided for post-installed anchors with category as determined from ACI 355.4 given for Condition B. Condition B applies without supplementary reinforcement or where pullout (bond) or pryout govern, as set forth in ACI 318-19 17.5.3, ACI 318-14 17.3.3 or ACI 318-11 D.4.3, as applicable, while condition A requires supplemental reinforcement. Values are for use with load combinations Section 1605.1 of the 2021 IBC, Section 1605.2 of the 2018, 2015, 2012 and 2009 IBC, ACI 318-19 and ACI 318-14 5.3 or ACI 318-11 9.2, as applicable, as set forth in ACI 318-19 17.5.3, ACI 318-14 17.3.3 or ACI 318-11 D.4.3, as applicable. If the load combinations of ACI 318-11 Appendix C are used, the appropriate value of ϕ must be determined in accordance with ACI 318-11 D.4.4.

TABLE 9—BOND STRENGTH DESIGN INFORMATION FOR METRIC THREADED ROD IN HOLES DRILLED WITH A HAMMER DRILL AND CARBIDE BIT^{1, 2}

DESIGN INFORMATION			Symbol	Units	Threaded Rod Diameter (mm)							
					8	10	12	16	20	24	27	30
Minimum Embedment Depth			$h_{ef,min}$	mm (in.)	60 (2.36)	60 (2.36)	70 (2.76)	80 (3.15)	90 (3.54)	96 (3.78)	108 (4.25)	120 (4.72)
Maximum Embedment Depth			$h_{ef,max}$	mm (in.)	160 (6.30)	200 (7.87)	240 (9.45)	320 (12.60)	400 (15.75)	480 (18.90)	540 (21.26)	600 (23.62)
Characteristic Bond Strength in Uncracked Concrete	Maximum Short Term Temperature = 162°F (72°C), Maximum Long Term Temperature = 109°F (43°C) ³	With Sustained Loads ⁴	$\tau_{k,uncr}$	N/mm ² (psi)	16.9 (2450)	16.2 (2345)	15.7 (2275)	15.0 (2170)	14.4 (2090)	13.9 (2020)	13.7 (1985)	13.4 (1950)
	Short Term Loads only ⁵			N/mm ² (psi)	21.1 (3060)	20.2 (2930)	19.6 (2845)	18.7 (2710)	18.0 (2610)	17.4 (2525)	17.1 (2480)	16.8 (2435)
	Maximum Short Term Temperature = 162°F (72°C), Maximum Long Term Temperature = 122°F (50°C) ³	With Sustained Loads ⁴		N/mm ² (psi)	12.9 (1865)	12.3 (1785)	12.0 (1735)	11.4 (1655)	11.0 (1595)	10.6 (1540)	10.4 (1515)	10.2 (1485)
	Short Term Loads only ⁵			N/mm ² (psi)	21.1 (3060)	20.2 (2930)	19.6 (2845)	18.7 (2710)	18.0 (2610)	17.4 (2525)	17.1 (2480)	16.8 (2435)
Characteristic Bond Strength in Cracked Concrete	Maximum Short Term Temperature = 162°F (72°C), Maximum Long Term Temperature = 109°F (43°C) ³	With Sustained Loads ⁴	$\tau_{k,cr}$	N/mm ² (psi)	9.8 (1425)	9.7 (1405)	9.4 (1370)	9.3 (1345)	9.1 (1325)	9.0 (1310)	9.0 (1300)	9.0 (1300)
	Short Term Loads only ⁵			N/mm ² (psi)	12.3 (1785)	12.1 (1755)	11.8 (1710)	11.6 (1680)	11.4 (1655)	11.3 (1640)	11.2 (1625)	11.2 (1625)
	Maximum Short Term Temperature = 162°F (72°C), Maximum Long Term Temperature = 122°F (50°C) ³	With Sustained Loads ⁴		N/mm ² (psi)	7.5 (1090)	7.4 (1070)	7.2 (1045)	7.1 (1025)	7.0 (1010)	6.9 (1000)	6.8 (990)	6.8 (990)
	Short Term Loads only ⁵			N/mm ² (psi)	12.3 (1785)	12.1 (1755)	11.8 (1710)	11.6 (1680)	11.4 (1655)	11.3 (1640)	11.2 (1625)	11.2 (1625)
Reduction Factor for Seismic Tension			$\alpha_{N,seis}$	-	-	0.97	0.96	0.94	0.92	0.90	0.89	0.88
Strength Reduction Factors for Permissible Installation Conditions	Dry Holes in Concrete	Continuous Inspection	ϕ_d	-	0.65			0.55				
		Periodic Inspection		-	0.65			0.55				
	Water Saturated Holes in Concrete	Continuous Inspection	ϕ_{ws}	-	0.55	0.65						
		Periodic Inspection		-	0.55	0.65						
	Water-filled Holes in Concrete	Continuous Inspection	ϕ_{wf}	-	0.45							
		Periodic Inspection		-	0.45							
	Underwater Installation in Concrete	Continuous Inspection	ϕ_{uw}	-	0.55							
		Periodic Inspection		-	0.55							
Modifi- cation Factors	Water-filled Holes in Concrete	Continuous Inspection	K_{wf}	-	0.91	0.92		0.89	0.88	0.86	0.83	
		Periodic Inspection		-	0.89	0.88	0.85	0.83	0.82	0.78	0.77	

For SI: 1 inch = 25.4 mm, 1 lbf = 4.448 N, 1 psi = 0.006897 MPa.

For pound-inch units: 1 mm = 0.03937 inch, 1 N = 0.2248 lbf, 1 MPa = 145.0 psi.

¹Characteristic bond strength values correspond to concrete compressive strength $f_c = 2,500$ psi (17.2 MPa). For uncracked concrete compressive strength f_c between 2,500 psi (17.2 MPa) and 8,000 psi (55.2 MPa) [minimum of 24 MPa is required under ADIBC Appendix L, Section 5.1.1], the tabulated characteristic bond strength may be increased by factor of $(f_c / 2,500)^{0.1}$ [for SI: $(f_c / 17.2)^{0.1}$]. See Section 4.1.4 of this report.

²Lightweight concrete may be used by applying a reduction factor as given in ACI 318-19 17.2.4, ACI 318-14 17.2.6 or ACI 318-11 Appendix D section D.3.6 as applicable.

³Short term elevated concrete temperatures are those that occur over brief intervals, e.g., as a result of diurnal cycling. Long term concrete temperatures are roughly constant over significant periods of time.

⁴Characteristic bond strengths are for sustained loads including dead and live loads.

⁵Characteristic bond strengths are for short-term loads including wind.

TABLE 10—BOND STRENGTH DESIGN INFORMATION FOR METRIC THREADED ROD IN HOLES DRILLED WITH A DIAMOND CORE BIT^{1,2}

DESIGN INFORMATION			Symbol	Units	Threaded Rod Diameter (mm)						
					10	12	16	20	24	27	30
Minimum Embedment Depth			$h_{ef,min}$	mm (in.)	60 (2.36)	70 (2.76)	80 (3.15)	90 (3.54)	96 (3.78)	108 (4.25)	120 (4.72)
Maximum Embedment Depth			$h_{ef,max}$	mm (in.)	200 (7.87)	240 (9.45)	320 (12.60)	400 (15.75)	480 (18.90)	540 (21.26)	600 (23.62)
Characteristic Bond Strength in Uncracked Concrete	Maximum Short Term Temperature = 162°F (72°C), Maximum Long Term Temperature = 109°F (43°C) ³	With Sustained Loads ⁴	$\tau_{k,uncr}$	N/mm ² (psi)	11.3 (1,635)	10.7 (1,555)	9.8 (1,425)	9.2 (1,335)	8.7 (1,265)	8.4 (1,220)	8.1 (1,170)
		Short Term Loads only ⁵		N/mm ² (psi)	14.1 (2,045)	13.4 (1,945)	12.3 (1,785)	11.5 (1,670)	10.9 (1,580)	10.5 (1,525)	10.1 (1,465)
	Maximum Short Term Temperature = 162°F (72°C), Maximum Long Term Temperature = 122°F (50°C) ³	With Sustained Loads ⁴		N/mm ² (psi)	8.6 (1,245)	8.2 (1,185)	7.5 (1,090)	7.0 (1,015)	6.6 (965)	6.4 (930)	6.2 (895)
		Short Term Loads only ⁵		N/mm ² (psi)	14.1 (2,045)	13.4 (1,945)	12.3 (1,785)	11.5 (1,670)	10.9 (1,580)	10.5 (1,525)	10.1 (1,465)
Characteristic Bond Strength in Cracked Concrete	Maximum Short Term Temperature = 162°F (72°C), Maximum Long Term Temperature = 109°F (43°C) ³	With Sustained Loads ⁴	$\tau_{k,cr}$	N/mm ² (psi)	6.6 (950)	6.6 (965)	6.7 (975)	6.8 (985)	6.6 (950)	6.5 (940)	6.4 (930)
		Short Term Loads only ⁵		N/mm ² (psi)	8.2 (1,190)	8.3 (1,205)	8.4 (1,220)	8.5 (1,235)	8.2 (1,190)	8.1 (1,175)	8.0 (1,160)
	Maximum Short Term Temperature = 162°F (72°C), Maximum Long Term Temperature = 122°F (50°C) ³	With Sustained Loads ⁴		N/mm ² (psi)	5.0 (725)	5.1 (735)	5.1 (745)	5.2 (750)	5.0 (725)	4.9 (715)	4.9 (710)
		Short Term Loads only ⁵		N/mm ² (psi)	8.2 (1,190)	8.3 (1,205)	8.4 (1,220)	8.5 (1,235)	8.2 (1,190)	8.1 (1,175)	8.0 (1,160)
Reduction Factor for Seismic Tension			$\alpha_{N,seis}$	-	0.97	0.96	0.94	0.92	0.90	0.89	0.88
Strength Reduction Factors for Permissible Installation Conditions	Dry Holes in Concrete	Continuous Inspection	ϕ_d	-	0.65			0.55		0.45	
		Periodic Inspection		-	0.65			0.55		0.45	
	Water Saturated Holes in Concrete	Continuous Inspection	ϕ_{ws}	-	0.65						
		Periodic Inspection		-	0.65			0.55		0.45	
	Water-filled Holes in Concrete	Continuous Inspection	ϕ_{wft}	-	0.45						
		Periodic Inspection		-	0.45						
	Underwater Installation in Concrete	Continuous Inspection	ϕ_{uw}	-	0.45		0.55				
		Periodic Inspection		-	0.45		0.55				
Modifi- cation Factors in Concrete	Water-filled Holes in Concrete	Continuous Inspection	K_{wft}	-	0.92	0.95	1.0				
		Periodic Inspection		-	0.91	0.92	0.95	0.97	0.95	0.92	

For **SI**: 1 inch = 25.4 mm, 1 lbf = 4.448 N, 1 psi = 0.006897 MPa.
 For **pound-inch** units: 1 mm = 0.03937 inches, 1 N = 0.2248 lbf, 1 MPa = 145.0 psi.

¹Characteristic bond strength values correspond to concrete compressive strength $f'_c = 2,500$ psi (17.2 MPa). For uncracked concrete compressive strength f'_c between 2,500 psi (17.2 MPa) and 8,000 psi (55.2 MPa) [minimum of 24 MPa is required under ADIBC Appendix L, Section 5.1.1], the tabulated characteristic bond strength may be increased by factor of $(f'_c / 2,500)^{0.1}$ [for SI: $(f'_c / 17.2)^{0.1}$]. See Section 4.1.4 of this report.

²Lightweight concrete may be used by applying a reduction factor as given in ACI 318-19 17.2.4, ACI 318-14 17.2.6 or ACI 318-11 Appendix D section D.3.6 as applicable.

³Short term elevated concrete temperatures are those that occur over brief intervals, e.g., as a result of diurnal cycling. Long term concrete temperatures are roughly constant over significant periods of time.

⁴Characteristic bond strengths are for sustained loads including dead and live loads.

⁵Characteristic bond strengths are for short-term loads including wind.

TABLE 11—BOND STRENGTH DESIGN INFORMATION FOR METRIC THREADED ROD IN HOLES DRILLED WITH A HAMMER DRILL AND HOLLOW DRILL BIT ^{1, 2}

DESIGN INFORMATION			Symbol	Units	Threaded Rod Diameter (mm)						
					10	12	16	20	24	27	30
Minimum Embedment Depth			$h_{ef,min}$	mm (in.)	60 (2.36)	70 (2.76)	80 (3.15)	90 (3.54)	96 (3.78)	108 (4.25)	120 (4.72)
Maximum Embedment Depth			$h_{ef,max}$	mm (in.)	200 (7.87)	240 (9.45)	320 (12.60)	400 (15.75)	480 (18.90)	540 (21.26)	600 (23.62)
Characteristic Bond Strength in Uncracked Concrete	Maximum Short Term Temperature = 162°F (72°C), Maximum Long Term Temperature = 109°F (43°C) ³	With Sustained Loads ⁴	$\tau_{k,un-cr}$	N/mm ² (psi)	15.6 (2,265)	14.9 (2,160)	13.8 (2,005)	13.1 (1,905)	12.6 (1,820)	12.2 (1,775)	11.9 (1,730)
	Short Term Loads only ⁵			N/mm ² (psi)	19.5 (2,830)	18.6 (2,700)	17.3 (2,510)	16.4 (2,380)	15.7 (2,275)	15.3 (2,220)	14.9 (2,160)
	Maximum Short Term Temperature = 162°F (72°C), Maximum Long Term Temperature = 122°F (50°C) ³	With Sustained Loads ⁴		N/mm ² (psi)	11.9 (1,725)	11.3 (1,645)	10.6 (1,530)	10.0 (1,450)	9.6 (1,390)	9.3 (1,355)	9.1 (1,320)
	Short Term Loads only ⁵			N/mm ² (psi)	19.5 (2,830)	18.6 (2,700)	17.3 (2,510)	16.4 (2,380)	15.7 (2,275)	15.3 (2,220)	14.9 (2,160)
Characteristic Bond Strength in Cracked Concrete	Maximum Short Term Temperature = 162°F (72°C), Maximum Long Term Temperature = 109°F (43°C) ³	With Sustained Loads ⁴	$\tau_{k,cr}$	N/mm ² (psi)	9.6 (1,390)	9.4 (1,370)	9.3 (1,345)	9.2 (1,335)	9.1 (1,325)	9.1 (1,325)	9.1 (1,325)
	Short Term Loads only ⁵			N/mm ² (psi)	12.0 (1,740)	11.8 (1,710)	11.6 (1,680)	11.5 (1,670)	11.4 (1,655)	11.4 (1,655)	11.4 (1,655)
	Maximum Short Term Temperature = 162°F (72°C), Maximum Long Term Temperature = 122°F (50°C) ³	With Sustained Loads ⁴		N/mm ² (psi)	7.3 (1,060)	7.2 (1,045)	7.1 (1,025)	7.0 (1,015)	7.0 (1,010)	7.0 (1,010)	7.0 (1,010)
	Short Term Loads only ⁵			N/mm ² (psi)	12.0 (1,740)	11.8 (1,710)	11.6 (1,680)	11.5 (1,670)	11.4 (1,655)	11.4 (1,655)	11.4 (1,655)
Reduction Factor for Seismic Tension			$\alpha_{N,seis}$	-	0.97	0.96	0.94	0.92	0.90	0.89	0.88
Strength Reduction Factors for Permissible Installation Conditions	Dry Holes in Concrete	Continuous Inspection	ϕ_d	-	0.65					0.55	
		Periodic Inspection		-	0.65					0.55	
	Water Saturated Holes in Concrete	Continuous Inspection	ϕ_{ws}	-	0.65						
		Periodic Inspection		-	0.65						

For **SI**: 1 inch = 25.4 mm, 1 lbf = 4.448 N, 1 psi = 0.006897 MPa.
 For **pound-inch** units: 1 mm = 0.03937 inches, 1 N = 0.2248 lbf, 1 MPa = 145.0 psi.

¹Characteristic bond strength values correspond to concrete compressive strength $f'_c = 2,500$ psi (17.2 MPa). For uncracked concrete compressive strength f'_c between 2,500 psi (17.2 MPa) and 8,000 psi (55.2 MPa) [minimum of 24 MPa is required under ADIBC Appendix L, Section 5.1.1], the tabulated characteristic bond strength may be increased by factor of $(f'_c / 2,500)^{0.1}$ [for SI: $(f'_c / 17.2)^{0.1}$]. See Section 4.1.4 of this report.

²Lightweight concrete may be used by applying a reduction factor as given in ACI 318-19 17.2.4, ACI 318-14 17.2.6 or ACI 318-11 Appendix D section D.3.6 as applicable.

³Short term elevated concrete temperatures are those that occur over brief intervals, e.g., as a result of diurnal cycling. Long term concrete temperatures are roughly constant over significant periods of time.

⁴Characteristic bond strengths are for sustained loads including dead and live loads.

⁵Characteristic bond strengths are for short-term loads including wind.

TABLE 12—STEEL DESIGN INFORMATION FOR METRIC REINFORCING BAR¹

DESIGN INFORMATION		Symbol	Units	Rebar size							
				10	12	16	20	25	28	32	
Nominal bar diameter		d_a	mm (in.)	10 (0.39)	12 (0.47)	16 (0.63)	20 (0.79)	25 (0.98)	28 (1.10)	32 (1.26)	
Bar effective cross-sectional area		A_{se}	mm ² (in. ²)	78.5 (0.122)	113.0 (0.175)	201.0 (0.312)	314.0 (0.487)	491.0 (0.761)	616.0 (0.955)	804.0 (1.246)	
DIN 488 B500B	Nominal strength as governed by steel strength		N_{sa}	kN (lb)	42.4 (9,530)	61.0 (13,720)	108.5 (24,400)	169.6 (38,120)	265.1 (59,605)	332.6 (74,780)	434.2 (97,605)
			V_{sa}	kN (lb)	25.4 (5,720)	36.6 (8,230)	65.1 (14,640)	101.7 (22,870)	159.1 (35,765)	199.6 (44,870)	260.5 (58,560)
	Reduction for seismic shear		$\alpha_{V,seis}$	-	1.0						
	Strength reduction factor ϕ for tension ²		ϕ	-	0.65						
	Strength reduction factor ϕ for shear ²		ϕ	-	0.60						

For **SI**: 1 inch = 25.4 mm, 1 lbf = 4.448 N, 1 psi = 0.006897 MPa.

For pound-inch units: 1 mm = 0.03937 inch, 1 N = 0.2248 lbf, 1 MPa = 150.0 psi.

¹Values provided for common reinforcing bar based on specified strength and calculated in accordance with ACI 318-19 Eq. 17.6.1.2, ACI 318-14 Eq. 17.4.1.2 and Eq. 17.5.1.2b or ACI 318-11 Eq. D-2 and Eq. D-29, as applicable.

²For use with load combinations Section 1605.1 of the 2021 IBC, Section 1605.2 of the 2018, 2015, 2012 and 2009 IBC, ACI 318-19 and ACI 318-14 5.3 or ACI 318-11 9.2, as applicable, as set forth in ACI 318-19 17.5.3, ACI 318-14 17.3.3 or ACI 318-11 D.4.3, as applicable. If the load combinations of ACI 318-11 Appendix C are used, the appropriate value of ϕ must be determined in accordance with ACI 318-11 D.4.4. Values correspond to a brittle steel element.

TABLE 13—CONCRETE BREAKOUT DESIGN INFORMATION FOR METRIC REINFORCING BAR

DESIGN INFORMATION		Symbol	Units	Rebar Size						
				10	12	16	20	25	28	32
Embedment Depth	Minimum	$h_{ef,min}$	mm (in.)	60 (2.36)	70 (2.76)	80 (3.15)	90 (3.54)	100 (3.94)	112 (4.41)	128 (5.04)
	Maximum	$h_{ef,max}$	mm (in.)	200 (7.87)	240 (9.45)	320 (12.60)	400 (15.75)	500 (19.69)	560 (22.05)	640 (25.20)
Effectiveness Factor	Uncracked Concrete	$k_{c,uncr}$	SI (in.lb)	10 (24)						
	Cracked Concrete	$k_{c,cr}$	SI (in.lb)	7.1 (17)						
Minimum Value	Anchor Spacing	s_{min}	mm (in.)	$s_{min} = c_{min}$						
	Edge Distance	c_{min}	mm (in.)	45 (1.77)	55 (2.17)	65 (2.56)	85 (3.35)	110 (4.33)	130 (5.12)	160 (6.30)
	Member Thickness	h_{min}	mm (in.)	$h_{ef} + 30$ (≥ 100) ($h_{ef} + 1.25$ ≥ 4)	$h_{ef} + 2d_o^1$					
Critical Value	Edge Distance for Splitting Failure	c_{ac}	mm (in.)	See Section 4.1.10 of this report.						
Strength reduction factor ϕ , concrete failure modes, Condition B ²	Tension	ϕ	-	0.65						
	Shear	ϕ	-	0.70						

For SI: 1 inch = 25.4 mm, 1 lbf = 4.448 N, 1 psi = 0.006897 MPa.

For pound-inch units: 1 mm = 0.03937 inch, 1 N = 0.2248 lbf, 1 MPa = 145.0 psi.

¹ d_o = drill hole diameter

²Values provided for post-installed anchors with category as determined from ACI 355.4 given for Condition B. Condition B applies without supplementary reinforcement or where pullout (bond) or pryout govern, as set forth in ACI 318-19 17.5.3, ACI 318-14 17.3.3 or ACI 318-11 D.4.3, as applicable, while condition A requires supplemental reinforcement. Values are for use with load combinations Section 1605.1 of the 2021 IBC, Section 1605.2 of the 2018, 2015, 2012 and 2009 IBC, ACI 318-19 and ACI 318-14 5.3 or ACI 318-11 9.2, as applicable, as set forth in ACI 318-19 17.5.3, ACI 318-14 17.3.3 or ACI 318-11 D.4.3, as applicable. If the load combinations of ACI 318-11 Appendix C are used, the appropriate value of ϕ must be determined in accordance with ACI 318-11 D.4.4.

TABLE 14—BOND STRENGTH DESIGN INFORMATION FOR METRIC REINFORCING BAR IN HOLES DRILLED WITH A HAMMER DRILL AND CARBIDE BIT^{1, 2}

DESIGN INFORMATION			Symbol	Units	Rebar Size						
					10	12	16	20	25	28	32
Minimum Embedment Depth			$h_{ef,min}$	mm (in.)	60 (2.36)	70 (2.76)	80 (3.15)	90 (3.54)	100 (3.94)	112 (4.41)	128 (5.04)
Maximum Embedment Depth			$h_{ef,max}$	mm (in.)	200 (7.87)	240 (9.45)	320 (12.60)	400 (15.75)	500 (19.69)	560 (22.05)	640 (25.20)
Characteristic Bond Strength in Uncracked Concrete	Maximum Short Term Temperature = 162°F (72°C), Maximum Long Term Temperature = 109°F (43°C) ³	With Sustained Loads ⁴	$\tau_{k,un-cr}$	N/mm ² (psi)	10.7 (1,555)	10.5 (1,520)	10.1 (1,460)	9.8 (1,415)	9.5 (1,380)	9.4 (1,360)	9.3 (1,345)
		Short Term Loads only ⁵		N/mm ² (psi)	13.4 (1,945)	13.1 (1,900)	12.6 (1,825)	12.2 (1,770)	11.9 (1,725)	11.7 (1,695)	11.6 (1,680)
	Maximum Short Term Temperature = 162°F (72°C), Maximum Long Term Temperature = 122°F (50°C) ³	With Sustained Loads ⁴		N/mm ² (psi)	8.2 (1,185)	8.0 (1,160)	7.7 (1,115)	7.4 (1,080)	7.3 (1,055)	7.1 (1,035)	7.1 (1,025)
		Short Term Loads only ⁵		N/mm ² (psi)	13.4 (1,945)	13.1 (1,900)	12.6 (1,825)	12.2 (1,770)	11.9 (1,725)	11.7 (1,695)	11.6 (1,680)
Characteristic Bond Strength in Cracked Concrete	Maximum Short Term Temperature = 162°F (72°C), Maximum Long Term Temperature = 109°F (43°C) ³	With Sustained Loads ⁴	$\tau_{k,cr}$	N/mm ² (psi)	7.2 (1,045)	7.2 (1,045)	7.3 (1,055)	7.3 (1,055)	7.4 (1,065)	7.4 (1,065)	7.4 (1,080)
		Short Term Loads only ⁵		N/mm ² (psi)	9.0 (1,305)	9.0 (1,305)	9.1 (1,320)	9.1 (1,320)	9.2 (1,335)	9.2 (1,335)	9.3 (1,350)
	Maximum Short Term Temperature = 162°F (72°C), Maximum Long Term Temperature = 122°F (50°C) ³	With Sustained Loads ⁴		N/mm ² (psi)	5.5 (795)	5.5 (795)	5.6 (805)	5.6 (805)	5.6 (815)	5.6 (815)	5.7 (825)
		Short Term Loads only ⁵		N/mm ² (psi)	9.0 (1,305)	9.0 (1,305)	9.1 (1,320)	9.1 (1,320)	9.2 (1,335)	9.2 (1,335)	9.3 (1,350)
Reduction Factor for Seismic Tension			$\alpha_{N,seis}$	-	0.97	0.96	0.94	0.92	0.90	0.88	0.87
Strength Reduction Factors for Permissible Installation Conditions	Dry Holes in Concrete	Continuous Inspection	ϕ_d	-	0.65			0.55			
		Periodic Inspection		-	0.65			0.55			
	Water Saturated Holes in Concrete	Continuous Inspection	ϕ_{ws}	-	0.65						
		Periodic Inspection		-	0.65						
	Water-filled Holes in Concrete	Continuous Inspection	ϕ_{wf}	-	0.45						
		Periodic Inspection		-	0.45						
	Underwater Installation in Concrete	Continuous Inspection	ϕ_{uw}	-	0.55						
		Periodic Inspection		-	0.55						
Modifi- cation Factors	Water-filled Holes in Concrete	Continuous Inspection	K_{wf}	-	0.92			0.89	0.88	0.86	0.86
		Periodic Inspection		-	0.88	0.85	0.83	0.82	0.78	0.77	

For SI: 1 inch = 25.4 mm, 1 lbf = 4.448 N, 1 psi = 0.006897 MPa.

For pound-inch units: 1 mm = 0.03937 inch, 1 N = 0.2248 lbf, 1 MPa = 145.0 psi.

¹Characteristic bond strength values correspond to concrete compressive $f'_c = 2,500$ psi (17.2 MPa). For uncracked concrete compressive strength f'_c between 2,500 psi (17.2 MPa) and 8,000 psi (55.2 MPa) [minimum of 24 MPa is required under ADIBC Appendix L, Section 5.1.1], the tabulated characteristic bond strength may be increased by factor of $(f'_c / 2,500)^{0.1}$ [for SI: $(f'_c / 17.2)^{0.1}$]. See Section 4.1.4 of this report.

²Lightweight concrete may be used by applying a reduction factor as given in ACI 318-19 17.2.4, ACI 318-14 17.2.6 or ACI 318-11 Appendix D section D.3.6 as applicable.

³Short term elevated concrete temperatures are those that occur over brief intervals, e.g., as a result of diurnal cycling. Long term concrete temperatures are roughly constant over significant periods of time.

⁴Characteristic bond strengths are for sustained loads including dead and live loads.

⁵Characteristic bond strengths are for short-term loads including wind.

**TABLE 15—BOND STRENGTH DESIGN INFORMATION FOR METRIC REINFORCING BAR
IN HOLES DRILLED WITH A DIAMOND CORE BIT^{1,2}**

DESIGN INFORMATION			Symbol	Units	Rebar Size							
					10	12	16	20	25	28	32	
Minimum Embedment Depth			$h_{ef,min}$	mm (in.)	60 (2.36)	70 (2.76)	80 (3.15)	90 (3.54)	100 (3.94)	112 (4.41)	128 (5.04)	
Maximum Embedment Depth			$h_{ef,max}$	mm (in.)	200 (7.87)	240 (9.45)	320 (12.60)	400 (15.75)	500 (19.69)	560 (22.05)	640 (25.20)	
Characteristic Bond Strength in Uncracked Concrete	Maximum Short Term Temperature = 162°F (72°C), Maximum Long Term Temperature = 109°F (43°C) ³	With Sustained Loads ⁴	$\tau_{k,un-cr}$	N/mm ² (psi)	7.1 (1,035)	7.0 (1,020)	7.0 (1,010)	6.9 (1,000)	6.8 (985)	6.7 (975)	6.7 (975)	
		Short Term Loads only ⁵		N/mm ² (psi)	8.9 (1,290)	8.8 (1,275)	8.7 (1,260)	8.6 (1,245)	8.5 (1,235)	8.4 (1,220)	8.4 (1,220)	
	Maximum Short Term Temperature = 162°F (72°C), Maximum Long Term Temperature = 122°F (50°C) ³	With Sustained Loads ⁴		N/mm ² (psi)	5.4 (785)	5.4 (780)	5.3 (770)	5.2 (760)	5.2 (750)	5.1 (745)	5.1 (745)	
		Short Term Loads only ⁵		N/mm ² (psi)	8.9 (1,290)	8.8 (1,275)	8.7 (1,260)	8.6 (1,245)	8.5 (1,235)	8.4 (1,220)	8.4 (1,220)	
Characteristic Bond Strength in Cracked Concrete	Maximum Short Term Temperature = 162°F (72°C), Maximum Long Term Temperature = 109°F (43°C) ³	With Sustained Loads ⁴	$\tau_{k,cr}$	N/mm ² (psi)	4.1 (590)	4.3 (625)	4.5 (650)	4.5 (650)	4.5 (650)	4.6 (660)	4.6 (660)	
		Short Term Loads only ⁵		N/mm ² (psi)	5.1 (740)	5.4 (785)	5.6 (810)	5.6 (810)	5.6 (810)	5.7 (825)	5.7 (825)	
	Maximum Short Term Temperature = 162°F (72°C), Maximum Long Term Temperature = 122°F (50°C) ³	With Sustained Loads ⁴		N/mm ² (psi)	3.1 (450)	3.3 (480)	3.4 (495)	3.4 (495)	3.4 (495)	3.5 (505)	3.5 (505)	
		Short Term Loads only ⁵		N/mm ² (psi)	5.1 (740)	5.4 (785)	5.6 (810)	5.6 (810)	5.6 (810)	5.7 (825)	5.7 (825)	
Reduction Factor for Seismic Tension			$\alpha_{N,seis}$	-	0.97	0.96	0.94	0.92	0.90	0.88	0.87	
Strength Reduction Factors for Permissible Installation Conditions	Dry Holes in Concrete	Continuous Inspection	ϕ_d	-	0.65			0.55				
		Periodic Inspection		-	0.65			0.55				
	Water Saturated Holes in Concrete	Continuous Inspection	ϕ_{ws}	-	0.65				0.55			
		Periodic Inspection		-	0.65			0.55				
	Water-filled Holes in Concrete	Continuous Inspection	ϕ_{wf}	-	0.45				0.55			
		Periodic Inspection		-	0.45				0.55			
	Underwater Installation in Concrete	Continuous Inspection	ϕ_{uw}	-	0.45		0.55					
		Periodic Inspection		-	0.45		0.55					
Modifi- cation Factors	Water-filled Holes in Concrete	Continuous Inspection	K_{wf}	-	0.92	0.95	1.0					
		Periodic Inspection		-	0.91	0.92	0.95	0.97		0.95		

For **SI**: 1 inch = 25.4 mm, 1 lbf = 4.448 N, 1 psi = 0.006897 MPa.

For **pound-inch** units: 1 mm = 0.03937 inches, 1 N = 0.2248 lbf, 1 MPa = 145.0 psi.

¹Characteristic bond strength values correspond to concrete compressive strength $f'_c = 2,500$ psi (17.2 MPa). For uncracked concrete compressive strength f'_c between 2,500 psi (17.2 MPa) and 8,000 psi (55.2 MPa) [minimum of 24 MPa is required under ADIBC Appendix L, Section 5.1.1], the tabulated characteristic bond strength may be increased by factor of $(f'_c / 2,500)^{0.1}$ [for SI: $(f'_c / 17.2)^{0.1}$]. See Section 4.1.4 of this report.

²Lightweight concrete may be used by applying a reduction factor as given in ACI 318-19 17.2.4, ACI 318-14 17.2.6 or ACI 318-11 Appendix D section D.3.6 as applicable.

³Short term elevated concrete temperatures are those that occur over brief intervals, e.g., as a result of diurnal cycling. Long term concrete temperatures are roughly constant over significant periods of time.

⁴Characteristic bond strengths are for sustained loads including dead and live loads.

⁵Characteristic bond strengths are for short-term loads including wind.

TABLE 16—BOND STRENGTH DESIGN INFORMATION FOR METRIC REINFORCING BAR IN HOLES DRILLED WITH A HAMMER DRILL AND HOLLOW DRILL BIT^{1, 2}

DESIGN INFORMATION			Symbol	Units	Rebar Size					
					10	12	16	20	25	28
Minimum Embedment Depth			$h_{ef,min}$	mm (in.)	60 (2.36)	70 (2.76)	80 (3.15)	90 (3.54)	100 (3.94)	112 (4.41)
Maximum Embedment Depth			$h_{ef,max}$	mm (in.)	200 (7.87)	240 (9.45)	320 (12.60)	400 (15.75)	500 (19.69)	560 (22.05)
Characteristic Bond Strength in Uncracked Concrete	Maximum Short Term Temperature = 162°F (72°C), Maximum Long Term Temperature = 109°F (43°C) ³	With Sustained Loads ⁴	$\tau_{k,uncr}$	N/mm ² (psi)	7.7 (1,115)	7.8 (1,135)	7.9 (1,150)	8.2 (1,185)	8.3 (1,205)	8.4 (1,220)
		Short Term Loads only ⁵		N/mm ² (psi)	9.6 (1,390)	9.8 (1,420)	9.9 (1,435)	10.2 (1,480)	10.4 (1,510)	10.5 (1,525)
	Maximum Short Term Temperature = 162°F (72°C), Maximum Long Term Temperature = 122°F (50°C) ³	With Sustained Loads ⁴		N/mm ² (psi)	5.9 (850)	6.0 (865)	6.0 (875)	6.2 (900)	6.3 (920)	6.4 (930)
		Short Term Loads only ⁵		N/mm ² (psi)	9.6 (1,390)	9.8 (1,420)	9.9 (1,435)	10.2 (1,480)	10.4 (1,510)	10.5 (1,525)
Characteristic Bond Strength in Cracked Concrete	Maximum Short Term Temperature = 162°F (72°C), Maximum Long Term Temperature = 109°F (43°C) ³	With Sustained Loads ⁴	$\tau_{k,cr}$	N/mm ² (psi)	5.0 (720)	5.1 (745)	5.4 (790)	5.8 (835)	6.1 (880)	6.3 (915)
		Short Term Loads only ⁵		N/mm ² (psi)	6.2 (900)	6.4 (930)	6.8 (985)	7.2 (1,045)	7.6 (1,100)	7.9 (1,145)
	Maximum Short Term Temperature = 162°F (72°C), Maximum Long Term Temperature = 122°F (50°C) ³	With Sustained Loads ⁴		N/mm ² (psi)	3.8 (550)	3.9 (565)	4.1 (600)	4.4 (635)	4.6 (670)	4.8 (700)
		Short Term Loads only ⁵		N/mm ² (psi)	6.2 (900)	6.4 (930)	6.8 (985)	7.2 (1,045)	7.6 (1,100)	7.9 (1,145)
Reduction Factor for Seismic Tension			$\alpha_{N,seis}$	-	0.97	0.96	0.94	0.92	0.90	0.88
Strength Reduction Factors for Permissible Installation Conditions	Dry Holes in Concrete	Continuous Inspection	ϕ_d	-	0.65					0.55
		Periodic Inspection		-	0.65					0.55
	Water Saturated Holes in Concrete	Continuous Inspection	ϕ_{ws}	-	0.65					
		Periodic Inspection		-	0.65					

For **SI**: 1 inch = 25.4 mm, 1 lbf = 4.448 N, 1 psi = 0.006897 MPa.

For **pound-inch** units: 1 mm = 0.03937 inches, 1 N = 0.2248 lbf, 1 MPa = 145.0 psi.

¹Characteristic bond strength values correspond to concrete compressive strength $f'_c = 2,500$ psi (17.2 MPa). For uncracked concrete compressive strength f'_c between 2,500 psi (17.2 MPa) and 8,000 psi (55.2 MPa) [minimum of 24 MPa is required under ADIBC Appendix L, Section 5.1.1], the tabulated characteristic bond strength may be increased by factor of $(f'_c / 2,500)^{0.1}$ [for SI: $(f'_c / 17.2)^{0.1}$]. See Section 4.1.4 of this report.

²Lightweight concrete may be used by applying a reduction factor as given in ACI 318-19 17.2.4, ACI 318-14 17.2.6 or ACI 318-11 Appendix D section D.3.6 as applicable.

³Short term elevated concrete temperatures are those that occur over brief intervals, e.g., as a result of diurnal cycling. Long term concrete temperatures are roughly constant over significant periods of time.

⁴Characteristic bond strengths are for sustained loads including dead and live loads.

⁵Characteristic bond strengths are for short-term loads including wind.

TABLE 17—STEEL DESIGN INFORMATION FOR RG M I INTERNAL THREADED (METRIC) ANCHOR¹

DESIGN INFORMATION	SYMBOL	UNITS	Anchor Metrical Thread Size					
			M8	M10	M12	M16	M20	
Nominal Anchor Diameter	d_e	mm (in.)	8 (0.31)	10 (0.39)	12 (0.47)	16 (0.63)	20 (0.79)	
Outer Anchor Diameter	d_a	mm (in.)	12.3 (0.48)	16.0 (0.63)	18.3 (0.72)	22.3 (0.88)	28.3 (1.11)	
Anchor effective cross-sectional area	A_{se}	mm ² (in. ²)	73.5 (0.114)	137.6 (0.213)	160.4 (0.249)	205.5 (0.319)	339.9 (0.527)	
Anchor ISO 898-1 Grade 5.8 with Bolt: ISO 898-1 Grade 5.8	Nominal strength as governed by steel strength	N_{sa}	kN (lb)	18.3 (4,115)	29.0 (6,520)	42.2 (9,475)	78.4 (17,615)	122.4 (27,515)
		V_{sa}	kN (lb)	11.0 (2,470)	17.4 (3,910)	25.3 (5,685)	47.0 (10,570)	73.4 (16,510)
	Reduction for seismic shear	$\alpha_{V,seis}$	-	-	1.0			
	Strength reduction factor ϕ for tension ²	ϕ	-	0.65				
	Strength reduction factor ϕ for shear ²	ϕ	-	0.60				
Anchor: ISO 898-1 Grade 8.8 with Bolt: ISO 898-1 Grade 8.8	Nominal strength as governed by steel strength	N_{sa}	kN (lb)	29.3 (6,580)	46.4 (10,430)	67.4 (15,160)	107.9 (24,255)	178.4 (40,115)
		V_{sa}	kN (lb)	17.6 (3,950)	27.8 (6,260)	40.5 (9,095)	75.2 (16,910)	117.5 (26,415)
	Reduction for seismic shear	$\alpha_{V,seis}$	-	-	0.90		-	
	Strength reduction factor ϕ for tension ²	ϕ	-	0.65				
	Strength reduction factor ϕ for shear ²	ϕ	-	0.60				
Anchor / Bolt ISO 3506-1 Grade 70 and HCR Grade 70	Nominal strength as governed by steel strength	N_{sa}	kN (lb)	25.6 (5,760)	40.6 (9,125)	59.0 (13,265)	109.7 (24,660)	171.4 (38,525)
		V_{sa}	kN (lb)	15.4 (3,455)	24.4 (5,475)	35.4 (7,960)	65.8 (14,795)	102.8 (23,115)
	Reduction for seismic shear	$\alpha_{V,seis}$	-	-	0.90			
	Strength reduction factor ϕ for tension ²	ϕ	-	0.65				
	Strength reduction factor ϕ for shear ²	ϕ	-	0.60				

For **SI**: 1 inch = 25.4 mm, 1 lbf = 4.448 N, 1 psi = 0.006897 MPa.

For **pound-inch** units: 1 mm = 0.03937 inches, 1 N = 0.2248 lbf, 1 MPa = 145.0 psi.

¹Values provided for fischer RG M I based on specified strength and calculated in accordance with ACI 318-14 Eq. 17.4.1.2 and Eq. 17.5.1.2b or ACI 318-11 Eq. D-2 and Eq. D-29, as applicable. Nuts and washers must be appropriated for the rod strength and type.

²For use with load combinations Section 1605.1 of the 2021 IBC, Section 1605.2 of the 2018, 2015, 2012 and 2009 IBC, ACI 318-19 and ACI 318-14 5.3 or ACI 318-11 9.2, as applicable, as set forth in ACI 318-19 17.5.3, ACI 318-14 17.3.3 or ACI 318-11 D.4.3, as applicable. If the load combinations of ACI 318-11 Appendix C are used, the appropriate value of ϕ must be determined in accordance with ACI 318-11 D.4.4. Values correspond to a brittle steel element.

TABLE 18—CONCRETE BREAKOUT DESIGN INFORMATION FOR RG M I INTERNAL THREADED (METRIC) ANCHOR

DESIGN INFORMATION		SYMBOL	UNITS	Anchor Metrical Thread Size				
				M8	M10	M12	M16	M20
Embedment depth		h_{ef}	mm (in.)	90 (3.54)	90 (3.54)	125 (4.92)	160 (6.30)	200 (7.87)
Effectiveness Factor	Uncracked Concrete	$k_{c,uncr}$	SI (in.lb)	10 (24)				
	Cracked Concrete	$k_{c,cr}$	SI (in.lb)	7.1 (17)				
Minimum Value	Anchor spacing	s_{min}	mm (in.)	$s_{min} = c_{min}$				
	Edge Distance	c_{min}	mm (in.)	55 (2.17)	65 (2.56)	75 (2.95)	95 (3.74)	125 (4.92)
	Member Thickness	h_{min}	mm (in.)	120 (4.72)	125 (4.92)	165 (6.50)	205 (8.07)	260 (10.24)
Critical Value	Edge Distance for Splitting Failure	c_{ac}	mm (in.)	See Section 4.1.10 of this report				
Strength reduction factor ϕ , concrete failure modes, Condition B ¹	Tension	ϕ	-	0.65				
	Shear	ϕ	-	0.70				

For **SI**: 1 inch = 25.4 mm, 1 lbf = 4.448 N, 1 psi = 0.006897 MPa.

For **pound-inch** units: 1 mm = 0.03937 inches, 1 N = 0.2248 lbf, 1 MPa = 145.0 psi.

¹Values provided for post-installed anchors with category as determined from ACI 355.4 given for Condition B. Condition B applies without supplementary reinforcement or where pullout (bond) or pryout govern, as set forth in ACI 318-19 17.5.3, ACI 318-14 17.3.3 or ACI 318-11 D.4.3, as applicable, while condition A requires supplemental reinforcement. Values are for use with load combinations Section 1605.1 of the 2021 IBC, Section 1605.2 of the 2018, 2015, 2012 and 2009 IBC, ACI 318-19 and ACI 318-14 5.3 or ACI 318-11 9.2, as applicable, as set forth in ACI 318-19 17.5.3, ACI 318-14 17.3.3 or ACI 318-11 D.4.3, as applicable. If the load combinations of ACI 318-11 Appendix C are used, the appropriate value of ϕ must be determined in accordance with ACI 318-11 D.4.4.

TABLE 19—BOND STRENGTH DESIGN INFORMATION FOR RG M I INTERNAL THREADED (METRIC) ANCHOR IN HOLES DRILLED WITH A HAMMER DRILL AND CARBIDE BIT^{1, 2}

DESIGN INFORMATION			Symbol	Units	Anchor Metrical Thread Size (mm)				
					8	10	12	16	20
Embedment Depth			h_{ef}	mm (in.)	90 (3.54)	90 (3.54)	125 (4.92)	160 (6.30)	200 (7.87)
Characteristic Bond Strength in Uncracked Concrete	Maximum Short Term Temperature = 162°F (72°C), Maximum Long Term Temperature = 109°F (43°C) ³	With Sustained Loads ⁴	$\tau_{k, uncr}$	N/mm ² (psi)	15.6 (2,265)	15.0 (2,170)	14.6 (2,125)	14.1 (2,040)	13.5 (1,960)
		Short Term Loads only ⁵		N/mm ² (psi)	19.5 (2,830)	18.7 (2,710)	18.3 (2,655)	17.6 (2,555)	16.9 (2,450)
	Maximum Short Term Temperature = 162°F (72°C), Maximum Long Term Temperature = 122°F (50°C) ³	With Sustained Loads ⁴		N/mm ² (psi)	11.9 (1,725)	11.4 (1,655)	11.2 (1,620)	10.7 (1,555)	10.3 (1,495)
		Short Term Loads only ⁵		N/mm ² (psi)	19.5 (2,830)	18.7 (2,710)	18.3 (2,655)	17.6 (2,555)	16.9 (2,450)
Characteristic Bond Strength in Cracked Concrete	Maximum Short Term Temperature = 162°F (72°C), Maximum Long Term Temperature = 109°F (43°C) ³	With Sustained Loads ⁴	$\tau_{k, cr}$	N/mm ² (psi)	9.5 (1,380)	9.3 (1,345)	9.1 (1,325)	9.0 (1,310)	9.0 (1,300)
		Short Term Loads only ⁵		N/mm ² (psi)	11.9 (1,725)	11.6 (1,680)	11.4 (1,655)	11.3 (1,640)	11.2 (1,625)
	Maximum Short Term Temperature = 162°F (72°C), Maximum Long Term Temperature = 122°F (50°C) ³	With Sustained Loads ⁴		N/mm ² (psi)	7.3 (1,055)	7.1 (1,025)	7.0 (1,010)	6.9 (1,000)	6.8 (990)
		Short Term Loads only ⁵		N/mm ² (psi)	11.9 (1,725)	11.6 (1,680)	11.4 (1,655)	11.3 (1,640)	11.2 (1,625)
Reduction Factor for Seismic Tension			$\alpha_{N, seis}$	-	-	0.94	0.93	0.91	0.88
Strength Reduction Factors for Permissible Installation Conditions	Dry Holes in Concrete	Continuous Inspection	ϕ_d	-	0.65		0.55		
		Periodic Inspection		-	0.65		0.55		
	Water Saturated Holes in Concrete	Continuous Inspection	ϕ_{ws}	-	0.65				
		Periodic Inspection		-	0.65				
	Water-filled Holes in Concrete	Continuous Inspection	ϕ_{wf}	-	0.45				
		Periodic Inspection		-	0.45				
	Underwater Installation in Concrete	Continuous Inspection	ϕ_{uw}	-	0.55				
		Periodic Inspection		-	0.55				
Modification Factors	Water-filled Holes in Concrete	Continuous Inspection	K_{wf}	-	0.92		0.91	0.89	0.85
		Periodic Inspection		-	0.86	0.83	0.82	0.80	0.77

For **SI**: 1 inch = 25.4 mm, 1 lbf = 4.448 N, 1 psi = 0.006897 MPa.

For **pound-inch** units: 1 mm = 0.03937 inches, 1 N = 0.2248 lbf, 1 MPa = 145.0 psi.

¹Characteristic bond strength values correspond to concrete compressive strength $f'_c = 2,500$ psi (17.2 MPa). For uncracked concrete compressive strength f'_c between 2,500 psi (17.2 MPa) and 8,000 psi (55.2 MPa) [minimum of 24 MPa is required under ADIBC Appendix L, Section 5.1.1], the tabulated characteristic bond strength may be increased by factor of $(f'_c / 2,500)^{0.1}$ [for SI: $(f'_c / 17.2)^{0.1}$]. See Section 4.1.4 of this report.

²Lightweight concrete may be used by applying a reduction factor as given in ACI 318-19 17.2.4, ACI 318-14 17.2.6 or ACI 318-11 Appendix D section D.3.6 as applicable.

³Short term elevated concrete temperatures are those that occur over brief intervals, e.g., as a result of diurnal cycling. Long term concrete temperatures are roughly constant over significant periods of time.

⁴Characteristic bond strengths are for sustained loads including dead and live loads.

⁵Characteristic bond strengths are for short-term loads including wind.

TABLE 20—BOND STRENGTH DESIGN INFORMATION FOR RG M I INTERNAL THREADED (METRIC) ANCHOR IN HOLES DRILLED WITH A DIAMOND CORE BIT ^{1,2}

DESIGN INFORMATION			Symbol	Units	Anchor Metric Thread Diameter (mm)				
					8	10	12	16	20
Embedment Depth			h_{ef}	mm (in.)	90 (3.54)	90 (3.54)	125 (4.92)	160 (6.30)	200 (7.87)
Characteristic Bond Strength in Uncracked Concrete	Maximum Short Term Temperature = 162°F (72°C), Maximum Long Term Temperature = 109°F (43°C) ³	With Sustained Loads ⁴	$\tau_{k,uncr}$	N/mm ² (psi)	10.6 (1,545)	9.8 (1,425)	9.4 (1,370)	8.9 (1,290)	8.2 (1,195)
		Short Term Loads only ⁵		N/mm ² (psi)	13.3 (1,930)	12.3 (1,785)	11.8 (1,710)	11.1 (1,610)	10.3 (1,495)
	Maximum Short Term Temperature = 162°F (72°C), Maximum Long Term Temperature = 122°F (50°C) ³	With Sustained Loads ⁴		N/mm ² (psi)	8.1 (1,175)	7.5 (1,090)	7.2 (1,045)	6.8 (980)	6.3 (910)
		Short Term Loads only ⁵		N/mm ² (psi)	13.3 (1,930)	12.3 (1,785)	11.8 (1,710)	11.1 (1,610)	10.3 (1,495)
Characteristic Bond Strength in Cracked Concrete	Maximum Short Term Temperature = 162°F (72°C), Maximum Long Term Temperature = 109°F (43°C) ³	With Sustained Loads ⁴	$\tau_{k,cr}$	N/mm ² (psi)	6.6 (965)	6.7 (975)	6.9 (1,000)	6.6 (965)	6.5 (940)
		Short Term Loads only ⁵		N/mm ² (psi)	8.3 (1,205)	8.4 (1,220)	8.6 (1,245)	8.3 (1,205)	8.1 (1,175)
	Maximum Short Term Temperature = 162°F (72°C), Maximum Long Term Temperature = 122°F (50°C) ³	With Sustained Loads ⁴		N/mm ² (psi)	5.1 (735)	5.1 (745)	5.2 (760)	5.1 (735)	4.9 (715)
		Short Term Loads only ⁵		N/mm ² (psi)	8.3 (1,205)	8.4 (1,220)	8.6 (1,245)	8.3 (1,205)	8.1 (1,175)
Reduction Factor for Seismic Tension			$\alpha_{N,seis}$	-	-	0.94	0.93	0.91	0.88
Strength Reduction Factors for Permissible Installation Conditions	Dry Holes in Concrete	Continuous Inspection	ϕ_d	-	0.65			0.55	0.45
		Periodic Inspection		-	0.65			0.55	0.45
	Water Saturated Holes in Concrete	Continuous Inspection	ϕ_{ws}	-	0.65				
		Periodic Inspection		-	0.65			0.55	0.45
	Water-filled Holes in Concrete	Continuous Inspection	ϕ_{wf}	-	0.45				
		Periodic Inspection		-	0.45				
Underwater Installation in Concrete	Continuous Inspection	ϕ_{uw}	-	0.45	0.55				
	Periodic Inspection		-	0.45	0.55				
Modification Factors	Water-filled Holes in Concrete	Continuous Inspection	K_{wf}	-	0.95				
		Periodic Inspection		-	0.94	0.95	0.97		0.95

For **SI**: 1 inch = 25.4 mm, 1 lbf = 4.448 N, 1 psi = 0.006897 MPa.

For **pound-inch** units: 1 mm = 0.03937 inches, 1 N = 0.2248 lbf, 1 MPa = 145.0 psi.

¹Characteristic bond strength values correspond to concrete compressive strength $f'_c = 2,500$ psi (17.2 MPa). For uncracked concrete compressive strength f'_c between 2,500 psi (17.2 MPa) and 8,000 psi (55.2 MPa) [minimum of 24 MPa is required under ADIBC Appendix L, Section 5.1.1], the tabulated characteristic bond strength may be increased by factor of $(f'_c / 2,500)^{0.1}$ [for SI: $(f'_c / 17.2)^{0.1}$]. See Section 4.1.4 of this report.

²Lightweight concrete may be used by applying a reduction factor as given in ACI 318-19 17.2.4, ACI 318-14 17.2.6 or ACI 318-11 Appendix D section D.3.6 as applicable.

³Short term elevated concrete temperatures are those that occur over brief intervals, e.g., as a result of diurnal cycling. Long term concrete temperatures are roughly constant over significant periods of time.

⁴Characteristic bond strengths are for sustained loads including dead and live loads.

⁵Characteristic bond strengths are for short-term loads including wind.

TABLE 21—BOND STRENGTH DESIGN INFORMATION FOR RG M I INTERNAL THREADED (METRIC) ANCHOR IN HOLES DRILLED WITH A HAMMER DRILL AND HOLLOW DRILL BIT ^{1, 2}

DESIGN INFORMATION			Symbol	Units	Anchor Metrical Thread Size (mm)				
					8	10	12	16	20
Embedment Depth			h_{ef}	mm (in.)	90 (3.54)	90 (3.54)	125 (4.92)	160 (6.30)	200 (7.87)
Characteristic Bond Strength in Uncracked Concrete	Maximum Short Term Temperature = 162°F (72°C), Maximum Long Term Temperature = 109°F (43°C) ³	With Sustained Loads ⁴	$\tau_{k, uncr}$	N/mm ² (psi)	14.8 (2,145)	13.8 (2,005)	13.4 (1,950)	12.8 (1,855)	12.1 (1,750)
		Short Term Loads only ⁵		N/mm ² (psi)	18.5 (2,685)	17.3 (2,510)	16.8 (2,435)	16.0 (2,320)	15.1 (2,190)
	Maximum Short Term Temperature = 162°F (72°C), Maximum Long Term Temperature = 122°F (50°C) ³	With Sustained Loads ⁴		N/mm ² (psi)	11.3 (1,635)	10.6 (1,530)	10.2 (1,485)	9.8 (1,415)	9.2 (1,335)
		Short Term Loads only ⁵		N/mm ² (psi)	18.5 (2,685)	17.3 (2,510)	16.8 (2,435)	16.0 (2,320)	15.1 (2,190)
Characteristic Bond Strength in Cracked Concrete	Maximum Short Term Temperature = 162°F (72°C), Maximum Long Term Temperature = 109°F (43°C) ³	With Sustained Loads ⁴	$\tau_{k, cr}$	N/mm ² (psi)	9.1 (1,325)	9.0 (1,310)	8.9 (1,290)	8.8 (1,275)	8.8 (1,275)
		Short Term Loads only ⁵		N/mm ² (psi)	11.4 (1,655)	11.3 (1,640)	11.1 (1,610)	11.0 (1,595)	11.0 (1,595)
	Maximum Short Term Temperature = 162°F (72°C), Maximum Long Term Temperature = 122°F (50°C) ³	With Sustained Loads ⁴		N/mm ² (psi)	7.0 (1,010)	6.9 (1,000)	6.8 (980)	6.7 (975)	6.7 (975)
		Short Term Loads only ⁵		N/mm ² (psi)	11.4 (1,655)	11.3 (1,640)	11.1 (1,610)	11.0 (1,595)	11.0 (1,595)
Reduction Factor for Seismic Tension			$\alpha_{N, seis}$	-	-	0.94	0.93	0.91	0.88
Strength Reduction Factors for Permissible Installation Conditions	Dry Holes in Concrete	Continuous Inspection	ϕ_d	-	0.65				0.55
		Periodic Inspection		-	0.65				0.55
	Water Saturated Holes in Concrete	Continuous Inspection	ϕ_{ws}	-	0.65				
		Periodic Inspection		-	0.65				

For **SI**: 1 inch = 25.4 mm, 1 lbf = 4.448 N, 1 psi = 0.006897 MPa.

For **pound-inch** units: 1 mm = 0.03937 inches, 1 N = 0.2248 lbf, 1 MPa = 145.0 psi.

¹Characteristic bond strength values correspond to concrete compressive strength $f_c = 2,500$ psi (17.2 MPa). For uncracked concrete compressive strength f_c between 2,500 psi (17.2 MPa) and 8,000 psi (55.2 MPa) [minimum of 24 MPa is required under ADIBC Appendix L, Section 5.1.1], the tabulated characteristic bond strength may be increased by factor of $(f_c / 2,500)^{0.1}$ [for SI: $(f_c / 17.2)^{0.1}$]. See Section 4.1.4 of this report.

²Lightweight concrete may be used by applying a reduction factor as given in ACI 318-19 17.2.4, ACI 318-14 17.2.6 or ACI 318-11 Appendix D section D.3.6 as applicable.

³Short term elevated concrete temperatures are those that occur over brief intervals, e.g., as a result of diurnal cycling. Long term concrete temperatures are roughly constant over significant periods of time.

⁴Characteristic bond strengths are for sustained loads including dead and live loads.

⁵Characteristic bond strengths are for short-term loads including wind.

TABLE 22—STEEL DESIGN INFORMATION FOR FRACTIONAL THREADED ROD¹

DESIGN INFORMATION		Symbol	Units	Nominal rod diameter (inch)							
				³ / ₈	¹ / ₂	⁵ / ₈	³ / ₄	⁷ / ₈	1	1 ¹ / ₈	1 ¹ / ₄
Rod Outside Diameter		d_a	in. (mm)	³ / ₈ (9.5)	¹ / ₂ (12.7)	⁵ / ₈ (15.9)	³ / ₄ (19.1)	⁷ / ₈ (22.2)	1 (25.4)	1 ¹ / ₈ (28.6)	1 ¹ / ₄ (31.8)
Rod effective cross-sectional area		A_{se}	in. ² (mm ²)	0.0775 (50.0)	0.1418 (91.5)	0.2260 (145.8)	0.3345 (215.8)	0.4617 (297.9)	0.6057 (390.8)	0.7626 (492.0)	0.9691 (625.2)
ASTM F568M Grade 5.8 / ISO 898-1 Grade 5.8	Nominal strength as governed by steel strength	N_{sa}	lb (kN)	5,620 (25.0)	10,285 (45.8)	16,390 (72.9)	24,255 (107.9)	33,485 (149.0)	43,930 (195.4)	55,305 (246.0)	70,275 (312.6)
		V_{sa}	lb (kN)	3,370 (15.0)	6,170 (27.5)	9,835 (43.7)	14,555 (64.7)	20,090 (89.4)	26,355 (117.2)	33,180 (147.6)	42,165 (187.6)
	Reduction for seismic shear	$\alpha_{V,seis}$	-	0.74				0.60			
	Strength reduction factor ϕ for tension ²	ϕ	-	0.65							
	Strength reduction factor ϕ for shear ²	ϕ	-	0.60							
ASTM A36 Grade 36 / F1554 Grade 36	Nominal strength as governed by steel strength	N_{sa}	lb (kN)	4,495 (20.0)	8,230 (36.6)	13,110 (58.3)	19,405 (86.3)	26,790 (119.2)	35,140 (156.3)	44,240 (196.8)	56,220 (250.1)
		V_{sa}	lb (kN)	2,700 (12.0)	4,935 (22.0)	7,865 (35.0)	11,645 (51.8)	16,075 (71.5)	21,085 (93.8)	26,545 (118.1)	33,730 (150.0)
	Reduction for seismic shear	$\alpha_{V,seis}$	-	0.74				0.60			
	Strength reduction factor ϕ for tension ³	ϕ	-	0.75							
	Strength reduction factor ϕ for shear ³	ϕ	-	0.65							
F1554 Grade 55	Nominal strength as governed by steel strength	N_{sa}	lb (kN)	5,810 (25.9)	10,635 (47.3)	16,945 (75.4)	25,080 (111.6)	34,625 (154.0)	45,420 (202.0)	57,185 (254.4)	72,665 (323.2)
		V_{sa}	lb (kN)	3,485 (15.5)	6,380 (28.4)	10,165 (45.2)	15,050 (66.9)	20,775 (92.4)	27,255 (121.2)	34,310 (152.6)	43,600 (193.9)
	Reduction for seismic shear	$\alpha_{V,seis}$	-	0.74				0.60			
	Strength reduction factor ϕ for tension ³	ϕ	-	0.75							
	Strength reduction factor ϕ for shear ³	ϕ	-	0.65							
ASTM A193 B7 ASTM F1554 Grade 105	Nominal strength as governed by steel strength	N_{sa}	lb (kN)	9,665 (43.0)	17,690 (78.7)	28,190 (125.4)	41,720 (185.6)	57,595 (256.2)	75,555 (336.1)	95,120 (423.1)	120,875 (537.7)
		V_{sa}	lb (kN)	5,800 (25.8)	10,615 (47.2)	16,915 (75.2)	25,035 (111.4)	34,555 (153.7)	45,335 (201.7)	57,075 (253.9)	72,525 (322.6)
	Reduction for seismic shear	$\alpha_{V,seis}$	-	0.74				0.60			
	Strength reduction factor ϕ for tension ²	ϕ	-	0.65							
	Strength reduction factor ϕ for shear ²	ϕ	-	0.60							

TABLE 22—STEEL DESIGN INFORMATION FOR FRACTIONAL THREADED ROD¹ (Continued)

DESIGN INFORMATION		Symbol	Units	Nominal rod diameter (inch)							
				3/8	1/2	5/8	3/4	7/8	1	1 1/8	1 1/4
ASTM A193 Grade B8 / B8M Grade 2B Stainless	Nominal strength as governed by steel strength	N_{sa}	lb (kN)	7,360 (32.8)	13,475 (59.9)	21,470 (95.5)	31,775 (141.3)	43,865 (195.1)	57,545 (256.0)	72,445 (322.3)	92,060 (409.5)
		V_{sa}	lb (kN)	4,415 (19.7)	8,085 (36.0)	12,880 (57.3)	19,065 (84.8)	26,320 (117.1)	34,525 (153.6)	43,470 (193.4)	55,235 (245.7)
	Reduction for seismic shear	$\alpha_{V,seis}$	-	0.74				0.60			
	Strength reduction factor ϕ for tension ³	ϕ	-	0.75							
	Strength reduction factor ϕ for shear ³	ϕ	-	0.65							
ASTM F593, CW Stainless	Nominal strength as governed by steel strength	N_{sa}	lb (kN)	6,585 (29.3)	12,055 (53.6)	19,205 (85.4)	28,430 (126.5)	39,245 (174.6)	51,485 (229.0)	64,815 (288.3)	82,365 (366.4)
		V_{sa}	lb (kN)	3,950 (17.6)	7,230 (32.2)	11,525 (51.3)	17,055 (75.9)	23,545 (104.7)	30,890 (137.4)	38,890 (173.0)	49,420 (219.8)
	Reduction for seismic shear	$\alpha_{V,seis}$	-	0.74				0.60			
	Strength reduction factor ϕ for tension ²	ϕ	-	0.65							
	Strength reduction factor ϕ for shear ²	ϕ	-	0.60							

For **SI**: 1 inch = 25.4 mm, 1lbf = 4.448 N, 1 psi = 0.006897 MPa.
 For pound-inch units: 1 mm = 0.03937 inch, 1 N = 0.2248 lbf, 1MPa = 145.0 psi.

¹Values provided for common rod material types are based on specified strength and calculated in accordance with ACI 318-19 Eq. 17.6.1.2, ACI 318-14 Eq. 17.4.1.2 and Eq. 17.5.1.2b or ACI 318-11 Eq. D-2 and Eq. D-29, as applicable. Nuts and washers must be appropriate for the rod strength and type.

²For use with load combinations Section 1605.1 of the 2021 IBC, Section 1605.2 of the 2018, 2015, 2012 and 2009 IBC, ACI 318-19 and ACI 318-14 5.3 or ACI 318-11 9.2, as applicable, as set forth in ACI 318-19 17.5.3, ACI 318-14 17.3.3 or ACI 318-11 D.4.3, as applicable. If the load combinations of ACI 318-11 Appendix C are used, the appropriate value of ϕ must be determined in accordance with ACI 318-11 D.4.4. Values correspond to a brittle steel element.

³For use with load combinations Section 1605.1 of the 2021 IBC, Section 1605.2 of the 2018, 2015, 2012 and 2009 IBC, ACI 318-19 and ACI 318-14 5.3 or ACI 318-11 9.2, as applicable, as set forth in ACI 318-19 17.5.3, ACI 318-14 17.3.3 or ACI 318-11 D.4.3, as applicable. If the load combinations of ACI 318-11 Appendix C are used, the appropriate value of ϕ must be determined in accordance with ACI 318-11 D.4.4. Values correspond to a ductile steel element.

TABLE 23—CONCRETE BREAKOUT DESIGN INFORMATION FOR FRACTIONAL THREADED ROD

DESIGN INFORMATION		Symbol	Units	Nominal rod diameter (inch)							
				³ / ₈	¹ / ₂	⁵ / ₈	³ / ₄	⁷ / ₈	1	1 ¹ / ₈	1 ¹ / ₄
Embedment Depth	Minimum	$h_{ef,min}$	in. (mm)	2 ³ / ₈ (60)	2 ³ / ₄ (70)	3 ¹ / ₈ (79)	3 ¹ / ₂ (89)	3 ¹ / ₂ (89)	4 (102)	4 ¹ / ₂ (114)	5 (127)
	Maximum	$h_{ef,max}$	in. (mm)	7 ¹ / ₂ (191)	10 (254)	12 ¹ / ₂ (318)	15 (381)	17 ¹ / ₂ (435)	20 (508)	22 ¹ / ₂ (572)	25 (635)
Effectiveness Factor	Uncracked Concrete	$k_{c,uncr}$	in.lb (SI)	24 (10)							
	Cracked Concrete	$k_{c,cr}$	in.lb (SI)	17 (7.1)							
Minimum Value	Anchor Spacing	s_{min}	in. (mm)	$s_{min} = c_{min}$							
	Edge Distance	c_{min}	in. (mm)	1.67 (42.5)	2.26 (57.5)	2.56 (65)	3.15 (80)	3.74 (95)	4.33 (110)	5.31 (135)	6.30 (160)
	Member Thickness	h_{min}	in. (mm)	$h_{ef} + 1.25 (\geq 4.0)$ $(h_{ef} + 30 [\geq 100])$		$h_{ef} + 2d_0^1$					
Critical Value	Edge Distance for Splitting Failure	c_{ac}	in. (mm)	See Section 4.1.10 of this report							
Strength reduction factor ϕ , concrete failure modes, Condition B ²	Tension	ϕ	-	0.65							
	Shear	ϕ	-	0.70							

For **SI**: 1 inch = 25.4 mm, 1lbf = 4.448 N, 1 psi = 0.006897 MPa.
 For pound-inch units: 1 mm = 0.03937 inch, 1 N = 0.2248 lbf, 1MPa = 145.0 psi.

¹ d_0 = drill hole diameter

² Values provided for post-installed anchors with category as determined from ACI 355.4 given for Condition B. Condition B applies without supplementary reinforcement or where pullout (bond) or pryout govern, as set forth in ACI 318-19 17.5.3, ACI 318-14 17.3.3 or ACI 318-11 D.4.3, while condition A requires supplemental reinforcement. Values are for use with the load combinations of 2021 IBC Section 1605.1, 2018, 2015, 2012 and 2009 IBC Section 1605.2 or ACI 318-19 and ACI 318-14 5.3 or ACI 318-11 Section 9.2 as set forth in ACI 318 D.4.3. If the load combinations of ACI 318 Appendix C are used, the appropriate value of ϕ must be determined in accordance with ACI 318-11 D.4.4.

TABLE 24—BOND STRENGTH DESIGN INFORMATION FOR FRACTIONAL THREADED ROD IN HOLES DRILLED WITH A HAMMER DRILL AND CARBIDE BIT ^{1,2}

DESIGN INFORMATION			Symbol	Units	Threaded Rod Diameter (inch)							
					³ / ₈	¹ / ₂	⁵ / ₈	³ / ₄	⁷ / ₈	1	¹ / ₈	¹ / ₄
Minimum Embedment Depth			$h_{ef,min}$	in. (mm)	2 ³ / ₈ (60)	2 ³ / ₄ (70)	3 ¹ / ₈ (79)	3 ¹ / ₂ (89)	3 ¹ / ₂ (89)	4 (102)	4 ¹ / ₂ (114)	5 (127)
Maximum Embedment Depth			$h_{ef,max}$	in. (mm)	7 ¹ / ₂ (191)	10 (254)	12 ¹ / ₂ (318)	15 (381)	17 ¹ / ₂ (445)	20 (508)	22 ¹ / ₂ (572)	25 (635)
Characteristic Bond Strength in Uncracked Concrete	Maximum Short Term Temperature = 162°F (72°C), Maximum Long Term Temperature = 109°F (43°C) ³	With Sustained Loads ⁴	$\tau_{k,uncr}$	psi (N/mm ²)	2,365 (16.3)	2,265 (15.6)	2,170 (15.0)	2,100 (14.5)	2,040 (14.1)	1,995 (13.8)	1,960 (13.5)	1,925 (13.3)
		Short Term Loads only ⁵		psi (N/mm ²)	2,960 (20.4)	2,830 (19.5)	2,710 (18.7)	2,625 (18.1)	2,555 (17.6)	2,495 (17.2)	2,450 (16.9)	2,410 (16.6)
	Maximum Short Term Temperature = 162°F (72°C), Maximum Long Term Temperature = 122°F (50°C) ³	With Sustained Loads ⁴		psi (N/mm ²)	1,805 (12.4)	1,725 (11.9)	1,655 (11.4)	1,600 (11.0)	1,555 (10.7)	1,520 (10.5)	1,495 (10.3)	1,470 (10.1)
		Short Term Loads only ⁵		psi (N/mm ²)	2,960 (20.4)	2,830 (19.5)	2,710 (18.7)	2,625 (18.1)	2,555 (17.6)	2,495 (17.2)	2,450 (16.9)	2,410 (16.6)
Characteristic Bond Strength in Cracked Concrete	Maximum Short Term Temperature = 162°F (72°C), Maximum Long Term Temperature = 109°F (43°C) ³	With Sustained Loads ⁴	$\tau_{k,cr}$	psi (N/mm ²)	1,415 (9.8)	1,370 (9.4)	1,335 (9.2)	1,325 (9.1)	1,310 (9.0)	1,300 (9.0)	1,300 (9.0)	1,300 (9.0)
		Short Term Loads only ⁵		psi (N/mm ²)	1,770 (12.2)	1,710 (11.8)	1,670 (11.5)	1,655 (11.4)	1,640 (11.3)	1,625 (11.2)	1,625 (11.2)	1,625 (11.2)
	Maximum Short Term Temperature = 162°F (72°C), Maximum Long Term Temperature = 122°F (50°C) ³	With Sustained Loads ⁴		psi (N/mm ²)	1,080 (7.4)	1,045 (7.2)	1,015 (7.0)	1,010 (7.0)	1,000 (6.9)	990 (6.8)	990 (6.8)	990 (6.8)
		Short Term Loads only ⁵		psi (N/mm ²)	1,770 (12.2)	1,710 (11.8)	1,670 (11.5)	1,655 (11.4)	1,640 (11.3)	1,625 (11.2)	1,625 (11.2)	1,625 (11.2)
Reduction Factor for Seismic Tension			$\alpha_{N,seis}$	-	0.97	0.96	0.94	0.93	0.91	0.90	0.88	0.87
Strength Reduction Factors for Permissible Installation Conditions	Dry Holes in Concrete	Continuous Inspection	ϕ_d	-	0.65			0.55				
		Periodic Inspection		-	0.65			0.55				
	Water Saturated Holes in Concrete	Continuous Inspection	ϕ_{ws}	-	0.55	0.65						
		Periodic Inspection		-	0.55	0.65						
	Water-filled Holes in Concrete	Continuous Inspection	ϕ_{wf}	-	0.45							
		Periodic Inspection		-	0.45							
	Underwater Installation in Concrete	Continuous Inspection	ϕ_{uw}	-	0.55							
		Periodic Inspection		-	0.55							
Modification Factors	Water-filled Holes in Concrete	Continuous Inspection	K_{wf}	-	0.91	0.92	0.91	0.89	0.88	0.85	0.82	
		Periodic Inspection		-	0.88	0.85	0.83	0.82	0.80	0.78	0.77	0.77

For SI: 1 inch = 25.4 mm, 1 lbf = 4.448 N, 1 psi = 0.006897 MPa.
 For pound-inch units: 1 mm = 0.03937 inch, 1 N = 0.2248 lbf, 1 MPa = 145.0 psi.

¹Characteristic bond strength values correspond to concrete compressive strength $f_c = 2,500$ psi (17.2 MPa). For uncracked concrete compressive strength f_c between 2,500 psi (17.2 MPa) and 8,000 psi (55.2 MPa) [minimum of 24 MPa is required under ADIBC Appendix L, Section 5.1.1], the tabulated characteristic bond strength may be increased by factor of $(f_c / 2,500)^{0.1}$ [for SI: $(f_c / 17.2)^{0.1}$]. See Section 4.1.4 of this report.

² Lightweight concrete may be used by applying a reduction factor as given in ACI 318-19 17.2.4, ACI 318-14 17.2.6 or ACI 318-11 Appendix D section D.3.6 as applicable.

³Short term elevated concrete temperatures are those that occur over brief intervals, e.g., as a result of diurnal cycling. Long term concrete temperatures are roughly constant over significant periods of time.

⁴Characteristic bond strengths are for sustained loads including dead and live loads.

⁵Characteristic bond strengths are for short-term loads including wind.

TABLE 25—BOND STRENGTH DESIGN INFORMATION FOR FRACTIONAL THREADED ROD IN HOLES DRILLED WITH A DIAMOND CORE BIT^{1,2}

DESIGN INFORMATION			Symbol	Units	Threaded Rod Diameter (inch)						
					1/2	5/8	3/4	7/8	1	1 1/8	1 1/4
Minimum Embedment Depth			$h_{ef,min}$	in. (mm)	2 3/4 (70)	3 1/8 (79)	3 1/2 (89)	3 1/2 (89)	4 (102)	4 1/2 (114)	5 (127)
Maximum Embedment Depth			$h_{ef,max}$	in. (mm)	10 (254)	12 1/2 (318)	15 (381)	17 1/2 (445)	20 (508)	22 1/2 (572)	25 (635)
Characteristic Bond Strength in Uncracked Concrete	Maximum Short Term Temperature = 162°F (72°C), Maximum Long Term Temperature = 109°F (43°C) ³	With Sustained Loads ⁴	$\tau_{k,uncr}$	psi (N/mm ²)	1,520 (10.5)	1,425 (9.8)	1,345 (9.3)	1,290 (8.9)	1,240 (8.6)	1,195 (8.2)	1,160 (8.0)
		Short Term Loads only ⁵		psi (N/mm ²)	1,900 (13.1)	1,785 (12.3)	1,680 (11.6)	1,610 (11.1)	1,550 (10.7)	1,495 (10.3)	1,450 (10.0)
	Maximum Short Term Temperature = 162°F (72°C), Maximum Long Term Temperature = 122°F (50°C) ³	With Sustained Loads ⁴		psi (N/mm ²)	1,160 (8.0)	1,090 (7.5)	1,025 (7.1)	980 (6.8)	945 (6.5)	910 (6.3)	885 (6.1)
		Short Term Loads only ⁵		psi (N/mm ²)	1,900 (13.1)	1,785 (12.3)	1,680 (11.6)	1,610 (11.1)	1,550 (10.7)	1,495 (10.3)	1,450 (10.0)
Characteristic Bond Strength in Cracked Concrete	Maximum Short Term Temperature = 162°F (72°C), Maximum Long Term Temperature = 109°F (43°C) ³	With Sustained Loads ⁴	$\tau_{k,cr}$	psi (N/mm ²)	965 (6.6)	975 (6.7)	985 (6.8)	965 (6.6)	940 (6.5)	930 (6.4)	915 (6.3)
		Short Term Loads only ⁵		psi (N/mm ²)	1,205 (8.3)	1,220 (8.4)	1,235 (8.5)	1,205 (8.3)	1,175 (8.1)	1,160 (8.0)	1,145 (7.9)
	Maximum Short Term Temperature = 162°F (72°C), Maximum Long Term Temperature = 122°F (50°C) ³	With Sustained Loads ⁴		psi (N/mm ²)	735 (5.1)	745 (5.1)	750 (5.2)	735 (5.1)	715 (4.9)	710 (4.9)	700 (4.8)
		Short Term Loads only ⁵		psi (N/mm ²)	1,205 (8.3)	1,220 (8.4)	1,235 (8.5)	1,205 (8.3)	1,175 (8.1)	1,160 (8.0)	1,145 (7.9)
Reduction Factor for Seismic Tension			$\alpha_{N,seis}$	-	0.96	0.94	0.93	0.91	0.90	0.88	0.87
Strength Reduction Factors for Permissible Installation Conditions	Dry Holes in Concrete	Continuous Inspection	ϕ_d	-	0.65		0.55		0.45		
		Periodic Inspection		-	0.65		0.55		0.45		
	Water Saturated Holes in Concrete	Continuous Inspection	ϕ_{ws}	-	0.65				0.45		
		Periodic Inspection		-	0.65		0.55		0.45		
	Water-filled Holes in Concrete	Continuous Inspection	ϕ_{wf}	-	0.45				0.45		
		Periodic Inspection		-	0.45				0.45		
	Underwater Installation in Concrete	Continuous Inspection	ϕ_{uw}	-	0.45	0.55				0.45	
		Periodic Inspection		-	0.45	0.55				0.45	
Modification Factors	Dry Holes in Concrete	Continuous Inspection	K_d	-	1.0					0.98	
		Periodic Inspection		-	1.0					0.98	
	Water Saturated Holes in Concrete	Continuous Inspection	K_{ws}	-	1.0					0.98	
		Periodic Inspection		-	1.0					0.98	
	Water-filled Holes in Concrete	Continuous Inspection	K_{wvf}	-	0.95	1.0				0.95	
		Periodic Inspection		-	0.94	0.97		0.95	0.94	0.92	

For **SI**: 1 inch = 25.4 mm, 1 lbf = 4.448 N, 1 psi = 0.006897 MPa.

For **pound-inch** units: 1 mm = 0.03937 inches, 1 N = 0.2248 lbf, 1 MPa = 145.0 psi.

¹Characteristic bond strength values correspond to concrete compressive strength $f'_c = 2,500$ psi (17.2 MPa). For uncracked concrete compressive strength f'_c between 2,500 psi (17.2 MPa) and 8,000 psi (55.2 MPa) [minimum of 24 MPa is required under ADIBC Appendix L, Section 5.1.1], the tabulated characteristic bond strength may be increased by factor of $(f'_c / 2,500)^{0.1}$ [for SI: $(f'_c / 17.2)^{0.1}$]. See Section 4.1.4 of this report.

²Lightweight concrete may be used by applying a reduction factor as given in ACI 318-19 17.2.4, ACI 318-14 17.2.6 or ACI 318-11 Appendix D section D.3.6 as applicable.

³Short term elevated concrete temperatures are those that occur over brief intervals, e.g., as a result of diurnal cycling. Long term concrete temperatures are roughly constant over significant periods of time.

⁴Characteristic bond strengths are for sustained loads including dead and live loads.

⁵Characteristic bond strengths are for short-term loads including wind.

TABLE 26—BOND STRENGTH DESIGN INFORMATION FOR FRACTIONAL THREADED ROD IN HOLES DRILLED WITH A HAMMER DRILL AND HOLLOW DRILL BIT ^{1,2}

DESIGN INFORMATION			Symbol	Units	Threaded Rod Diameter (inch) ⁶						
					³ / ₈	¹ / ₂	⁵ / ₈	³ / ₄	⁷ / ₈	1	1 ¹ / ₄
Minimum Embedment Depth			$h_{ef,min}$	in. (mm)	2 ³ / ₈ (60)	2 ³ / ₄ (70)	3 ¹ / ₈ (79)	3 ¹ / ₂ (89)	3 ¹ / ₂ (89)	4 (102)	5 (127)
Maximum Embedment Depth			$h_{ef,max}$	in. (mm)	7 ¹ / ₂ (191)	10 (254)	12 ¹ / ₂ (318)	15 (381)	17 ¹ / ₂ (445)	20 (508)	25 (635)
Characteristic Bond Strength in Uncracked Concrete	Maximum Short Term Temperature = 162°F (72°C), Maximum Long Term Temperature = 109°F (43°C) ³	With Sustained Loads ⁴	$\tau_{k,uncr}$	psi (N/mm ²)	2,285 (15.8)	2,135 (14.7)	2,020 (13.9)	1,925 (13.3)	1,855 (12.8)	1,800 (12.4)	1,705 (11.8)
		Short Term Loads only ⁵		psi (N/mm ²)	2,855 (19.7)	2,670 (18.4)	2,525 (17.4)	2,410 (16.6)	2,320 (16.0)	2,250 (15.5)	2,130 (14.7)
	Maximum Short Term Temperature = 162°F (72°C), Maximum Long Term Temperature = 122°F (50°C) ³	With Sustained Loads ⁴		psi (N/mm ²)	1,745 (12.0)	1,630 (11.2)	1,540 (10.6)	1,470 (10.1)	1,415 (9.8)	1,370 (9.5)	1,300 (9.0)
		Short Term Loads only ⁵		psi (N/mm ²)	2,855 (19.7)	2,670 (18.4)	2,525 (17.4)	2,410 (16.6)	2,320 (16.0)	2,250 (15.5)	2,130 (14.7)
Characteristic Bond Strength in Cracked Concrete	Maximum Short Term Temperature = 162°F (72°C), Maximum Long Term Temperature = 109°F (43°C) ³	With Sustained Loads ⁴	$\tau_{k,cr}$	psi (N/mm ²)	1,390 (9.6)	1,370 (9.4)	1,335 (9.2)	1,325 (9.1)	1,325 (9.1)	1,310 (9.0)	1,325 (9.1)
		Short Term Loads only ⁵		psi (N/mm ²)	1,740 (12.0)	1,710 (11.8)	1,670 (11.5)	1,655 (11.4)	1,655 (11.4)	1,640 (11.3)	1,655 (11.4)
	Maximum Short Term Temperature = 162°F (72°C), Maximum Long Term Temperature = 122°F (50°C) ³	With Sustained Loads ⁴		psi (N/mm ²)	1,060 (7.3)	1,045 (7.2)	1,015 (7.0)	1,010 (7.0)	1,010 (7.0)	1,000 (6.9)	1,010 (7.0)
		Short Term Loads only ⁵		psi (N/mm ²)	1,740 (12.0)	1,710 (11.8)	1,670 (11.5)	1,655 (11.4)	1,655 (11.4)	1,640 (11.3)	1,655 (11.4)
Reduction Factor for Seismic Tension			$\alpha_{N,seis}$	-	0.97	0.96	0.94	0.93	0.91	0.90	0.87
Strength Reduction Factors for Permissible Installation Conditions	Dry Holes in Concrete	Continuous Inspection	ϕ_d	-	0.65						0.55
		Periodic Inspection		-	0.65						0.55
	Water Saturated Holes in Concrete	Continuous Inspection	ϕ_{ws}	-	0.65						
		Periodic Inspection		-	0.65						0.55

For **SI**: 1 inch = 25.4 mm, 1 lbf = 4.448 N, 1 psi = 0.006897 MPa.

For **pound-inch** units: 1 mm = 0.03937 inches, 1 N = 0.2248 lbf, 1 MPa = 145.0 psi.

¹Characteristic bond strength values correspond to concrete compressive strength $f_c = 2,500$ psi (17.2 MPa). For uncracked concrete compressive strength f_c between 2,500 psi (17.2 MPa) and 8,000 psi (55.2 MPa) [minimum of 24 MPa is required under ADIBC Appendix L, Section 5.1.1], the tabulated characteristic bond strength may be increased by factor of $(f_c / 2,500)^{0.1}$ [for SI: $(f_c / 17.2)^{0.1}$]. See Section 4.1.4 of this report.

²Lightweight concrete may be used by applying a reduction factor as given in ACI 318-19 17.2.4, ACI 318-14 17.2.6 or ACI 318-11 Appendix D section D.3.6 as applicable.

³Short term elevated concrete temperatures are those that occur over brief intervals, e.g., as a result of diurnal cycling. Long term concrete temperatures are roughly constant over significant periods of time.

⁴Characteristic bond strengths are for sustained loads including dead and live loads.

⁵Characteristic bond strengths are for short-term loads including wind.

⁶Size ³/₈ only allowed with Hollow drill bit brand fischer / Bosch.

TABLE 27—STEEL DESIGN INFORMATION FOR FRACTIONAL REINFORCING BAR¹

DESIGN INFORMATION		Symbol	Units	Rebar size								
				#3	#4	#5	#6	#7	#8	#9	#10	#11
Nominal Bar Diameter		d_a	in. (mm)	³ / ₈ (9.5)	¹ / ₂ (12.7)	⁵ / ₈ (15.9)	³ / ₄ (19.1)	⁷ / ₈ (22.2)	1 (25.4)	¹ / ₈ (28.6)	¹ / ₄ (31.8)	³ / ₈ (34.9)
Bar effective cross-sectional area		A_{se}	ln. ² (mm ²)	0.11 (71)	0.20 (129)	0.31 (199)	0.44 (284)	0.60 (387)	0.79 (510)	1.00 (645)	1.27 (819)	1.56 (1006)
ASTM A615 Grade 40	Nominal strength as governed by steel strength	N_{sa}	lb (kN)	6,610 (29.4)	12,005 (53.4)	18,520 (82.4)	26,430 (117.6)	36,020 (160.2)	47,465 (211.1)	60,030 (267.0)	76,225 (339.1)	93,600 (416.4)
		V_{sa}	lb (kN)	3,965 (17.6)	7,205 (32.0)	11,115 (49.4)	15,860 (70.5)	21,610 (96.1)	28,480 (126.7)	36,020 (160.2)	45,735 (203.4)	56,160 (249.8)
	Reduction for seismic shear	$\alpha_{V,seis}$	-	0.74								
	Strength reduction factor ϕ for tension ²	ϕ	-	0.65								
	Strength reduction factor ϕ for shear ²	ϕ	-	0.60								
ASTM A615 Grade 60	Nominal strength as governed by steel strength	N_{sa}	lb (kN)	9,910 (44.1)	18,010 (80.1)	27,780 (123.6)	39,650 (176.4)	54,030 (240.3)	71,200 (316.7)	90,045 (400.5)	114,340 (508.6)	140,400 (624.5)
		V_{sa}	lb (kN)	5,945 (26.5)	10,805 (48.1)	16,670 (74.1)	23,790 (105.8)	32,415 (144.2)	42,720 (190.0)	54,030 (240.3)	68,605 (305.2)	84,240 (374.7)
	Reduction for seismic shear	$\alpha_{V,seis}$	-	0.74								
	Strength reduction factor ϕ for tension ²	ϕ	-	0.65								
	Strength reduction factor ϕ for shear ²	ϕ	-	0.60								
ASTM A706 Grade 60	Nominal strength as governed by steel strength	N_{sa}	lb (kN)	8,810 (39.2)	16,010 (71.2)	24,695 (109.8)	35,245 (156.8)	48,025 (213.6)	63,290 (281.5)	80,040 (356.0)	101,635 (452.1)	124,800 (555.1)
		V_{sa}	lb (kN)	5,285 (23.5)	9,605 (42.7)	14,815 (65.9)	21,145 (94.1)	28,815 (128.2)	37,975 (168.9)	48,025 (213.6)	60,980 (271.3)	74,880 (333.0)
	Reduction for seismic shear	$\alpha_{V,seis}$	-	0.74								
	Strength reduction factor ϕ for tension ²	ϕ	-	0.65								
	Strength reduction factor ϕ for shear ²	ϕ	-	0.60								

For **SI**: 1 inch = 25.4 mm, 1lbf = 4.448 N, 1 psi = 0.006897 MPa.
 For pound-inch units: 1 mm = 0.03937 inch, 1 N = 0.2248 lbf, 1MPa = 145.0 psi.

¹Values provided for common rod material types are based on specified strength and calculated in accordance with ACI 318-19 Eq. 17.6.1.2, ACI 318-14 Eq. 17.4.1.2 and Eq. 17.5.1.2b or ACI 318-11 Eq. D-2 and Eq. D-29, as applicable.

²For use with load combinations section 1605.1 of the 2021 IBC, Section 1605.2 of the 2018, 2015, 2012 and 2009 IBC, ACI 318-19 and ACI 318-14 5.3 or ACI 318-11 9.2, as applicable, as set forth in ACI 318-19 17.5.3, ACI 318-14 17.3.3 or ACI 318-11 D.4.3, as applicable. If the load combinations of ACI 318-11 Appendix C are used, the appropriate value of ϕ must be determined in accordance with ACI 318-11 D.4.4. Values correspond to a brittle steel element.

TABLE 28—CONCRETE BREAKOUT DESIGN INFORMATION FOR FRACTIONAL REINFORCING BAR

DESIGN INFORMATION		Symbol	Units	Rebar Size								
				#3	#4	#5	#6	#7	#8	#9	#10	#11
Embedment Depth	Minimum	$h_{ef,min}$	in. (mm)	2 ³ / ₈ (60)	2 ³ / ₄ (70)	3 ¹ / ₈ (79)	3 ¹ / ₂ (89)	3 ¹ / ₂ (89)	4 (102)	4 ¹ / ₂ (114)	5 (127)	5 ¹ / ₂ (140)
	Maximum	$h_{ef,max}$	in. (mm)	7 ¹ / ₂ (191)	10 (254)	12 ¹ / ₂ (318)	15 (381)	17 ¹ / ₂ (445)	20 (508)	22 ¹ / ₂ (572)	25 (635)	27 ¹ / ₂ (699)
Effectiveness Factor	Uncracked Concrete	$k_{c,uncr}$	in.lb (SI)	24 (10)								
	Cracked Concrete	$k_{c,cr}$	in.lb (SI)	17 (7.1)								
Minimum Value	Anchor Spacing	s_{min}	in. (mm)	$s_{min} = c_{min}$								
	Edge Distance	c_{min}	in. (mm)	1.69 (43)	2.28 (58)	2.56 (65)	3.15 (80)	3.74 (95)	4.33 (110)	5.12 (130)	6.30 (160)	6.89 (175)
	Member Thickness	h_{min}	in. (mm)	$h_{ef} + 1.25$ (≥ 4.0) $(h_{ef} + 30$ (≥ 100))	$h_{ef} + 2d_0^1$							
Critical Value	Edge Distance for Splitting Failure	c_{ac}	in. (mm)	See Section 4.1.10 of this report								
Strength reduction factor ϕ , concrete failure modes, Condition B ²	Tension	ϕ	-	0.65								
	Shear	ϕ	-	0.70								

For **SI**: 1 inch = 25.4 mm, 1lbf = 4.448 N, 1 psi = 0.006897 MPa.
 For pound-inch units: 1 mm = 0.03937 inch, 1 N = 0.2248 lbf, 1MPa = 145.0 psi.

¹ d_0 = drill hole diameter

²Values provided for post-installed anchors with category as determined from ACI 355.4 given for Condition B. Condition B applies without supplementary reinforcement or where pullout (bond) or pryout govern, as set forth in ACI 318-19 17.5.3, ACI 318-14 17.3.3 or ACI 318-11 D.4.3, as applicable, while condition A requires supplemental reinforcement. Values are for use with the load combinations of 2021 IBC Section 1605.1, 2018, 2015, 2012 and 2009 IBC Section 1605.2, ACI 318-19 and ACI 318-14 5.3 or ACI 318-11 Section 9.2, as applicable, as set forth in ACI 318-19 17.5.3, ACI 318-14 17.3.3 or ACI 318-11 D.4.3, as applicable. If the load combinations of ACI 318-11 Appendix C are used, the appropriate value of ϕ must be determined in accordance with ACI 318-11 D.4.4.

TABLE 29—BOND STRENGTH DESIGN INFORMATION FOR FRACTIONAL REINFORCING BAR IN HOLES DRILLED WITH A HAMMER DRILL AND CARBIDE BIT ^{1,2,6}

DESIGN INFORMATION			Symbol	Units	Rebar Size								
					#3	#4	#5	#6	#7	#8	#9	#10	#11
Minimum Embedment Depth			$h_{ef,min}$	in. (mm)	2 ³ / ₈ (60)	2 ³ / ₄ (70)	3 ¹ / ₈ (79)	3 ¹ / ₂ (89)	3 ¹ / ₂ (89)	4 (102)	4 ¹ / ₂ (114)	5 (127)	5 ¹ / ₂ (140)
Maximum Embedment Depth			$h_{ef,max}$	in. (mm)	7 ¹ / ₂ (191)	10 (254)	12 ¹ / ₂ (318)	15 (381)	17 ¹ / ₂ (445)	20 (508)	22 ¹ / ₂ (572)	25 (635)	27 ¹ / ₂ (699)
Characteristic Bond Strength in Uncracked Concrete	Maximum Short Term Temperature = 162°F (72°C), Maximum Long Term Temperature = 109°F (43°C) ³	With Sustained Loads ⁴	$\tau_{k,uncr}$	psi (N/mm ²)	1,555 (10.7)	1,510 (10.4)	1,460 (10.1)	1,440 (9.9)	1,405 (9.7)	1,380 (9.5)	1,360 (9.4)	1,345 (9.3)	740 (5.1)
		Short Term Loads only ⁵		psi (N/mm ²)	1,945 (13.4)	1,885 (13.0)	1,825 (12.6)	1,800 (12.4)	1,755 (12.1)	1,725 (11.9)	1,695 (11.7)	1,680 (11.6)	1,030 (7.1)
	Maximum Short Term Temperature = 162°F (72°C), Maximum Long Term Temperature = 122°F (50°C) ³	With Sustained Loads ⁴		psi (N/mm ²)	1,185 (8.2)	1,150 (7.9)	1,115 (7.7)	1,095 (7.6)	1,070 (7.4)	1,055 (7.3)	1,035 (7.1)	1,025 (7.1)	740 (5.1)
		Short Term Loads only ⁵		psi (N/mm ²)	1,945 (13.4)	1,885 (13.0)	1,825 (12.6)	1,800 (12.4)	1,755 (12.1)	1,725 (11.9)	1,695 (11.7)	1,680 (11.6)	1,030 (7.1)
Characteristic Bond Strength in Cracked Concrete	Maximum Short Term Temperature = 162°F (72°C), Maximum Long Term Temperature = 109°F (43°C) ³	With Sustained Loads ⁴	$\tau_{k,cr}$	psi (N/mm ²)	1,055 (7.3)	1,045 (7.2)	1,045 (7.2)	1,055 (7.3)	1,055 (7.3)	1,055 (7.3)	1,065 (7.4)	1,080 (7.4)	690 (4.8)
		Short Term Loads only ⁵		psi (N/mm ²)	1,320 (9.1)	1,305 (9.0)	1,305 (9.0)	1,320 (9.1)	1,320 (9.1)	1,320 (9.1)	1,335 (9.2)	1,350 (9.3)	955 (6.6)
	Maximum Short Term Temperature = 162°F (72°C), Maximum Long Term Temperature = 122°F (50°C) ³	With Sustained Loads ⁴		psi (N/mm ²)	805 (5.6)	795 (5.5)	795 (5.5)	805 (5.6)	805 (5.6)	805 (5.6)	815 (5.6)	825 (5.7)	690 (4.8)
		Short Term Loads only ⁵		psi (N/mm ²)	1,320 (9.1)	1,305 (9.0)	1,305 (9.0)	1,320 (9.1)	1,320 (9.1)	1,320 (9.1)	1,335 (9.2)	1,350 (9.3)	955 (6.6)
Reduction Factor for Seismic Tension			$\alpha_{N,seis}$	-	0.97	0.96	0.94	0.93	0.92	0.90	0.88	0.87	1.00
Strength Reduction Factors for Permissible Installation Conditions	Dry Holes in Concrete	Continuous Inspection	ϕ_{td}	-	0.65			0.55					
		Periodic Inspection		-	0.65			0.55					
	Water Saturated Holes in Concrete	Continuous Inspection	ϕ_{ws}	-	0.55	0.65			0.55				
		Periodic Inspection		-	0.55	0.65			0.55				
	Water-filled Holes in Concrete	Continuous Inspection	ϕ_{wf}	-	0.45						N/A		
		Periodic Inspection		-	0.45						N/A		
	Underwater Installation in Concrete	Continuous Inspection	ϕ_{uw}	-	0.55						N/A		
		Periodic Inspection		-	0.55						N/A		
Modifi- cation Factors	Water-filled Holes in Concrete	Continuous Inspection	K_{wf}	-	0.91	0.92	0.91	0.89	0.88	0.82		N/A	
		Periodic Inspection		-	0.88	0.85	0.83	0.82	0.80	0.78	0.77	N/A	

For SI: 1 inch = 25.4 mm, 1 lbf = 4.448 N, 1 psi = 0.006897 MPa.
For pound-inch units: 1 mm = 0.03937 inch, 1 N = 0.2248 lbf, 1 MPa = 145.0 psi.

¹Characteristic bond strength values correspond to concrete compressive strength $f_c = 2,500$ psi (17.2 MPa). For uncracked concrete compressive strength f_c between 2,500 psi (17.2 MPa) and 8,000 psi (55.2 MPa) [minimum of 24 MPa is required under ADIBC Appendix L, Section 5.1.1], the tabulated characteristic bond strength may be increased by factor of $(f_c / 2,500)^{0.1}$ [for SI: $(f_c / 17.2)^{0.1}$]. See Section 4.1.4 of this report.

² Lightweight concrete may be used by applying a reduction factor as given in ACI 318-19 17.2.4, ACI 318-14 17.2.6 or ACI 318-11 Appendix D section D.3.6 as applicable.

³Short term elevated concrete temperatures are those that occur over brief intervals, e.g., as a result of diurnal cycling. Long term concrete temperatures are roughly constant over significant periods of time.

⁴Characteristic bond strengths are for sustained loads including dead and live loads.

⁵Characteristic bond strengths are for short-term loads including wind.

⁶N/A indicates evaluation is beyond the scope of this report.

TABLE 30—BOND STRENGTH DESIGN INFORMATION FOR FRACTIONAL REINFORCING BAR IN HOLES DRILLED WITH A DIAMOND CORE BIT^{1,2}

DESIGN INFORMATION			Symbol	Units	Rebar Size							
					#3	#4	#5	#6	#7	#8	#9	#10
Minimum Embedment Depth			$h_{ef,min}$	in. (mm)	2 ³ / ₈ (60)	2 ³ / ₄ (70)	3 ¹ / ₈ (79)	3 ¹ / ₂ (89)	3 ¹ / ₂ (89)	4 (102)	4 ¹ / ₂ (114)	5 (127)
Maximum Embedment Depth			$h_{ef,max}$	in. (mm)	7 ¹ / ₂ (191)	10 (254)	12 ¹ / ₂ (318)	15 (381)	17 ¹ / ₂ (445)	20 (508)	22 ¹ / ₂ (572)	25 (635)
Characteristic Bond Strength in Uncracked Concrete	Maximum Short Term Temperature = 162°F (72°C), Maximum Long Term Temperature = 109°F (43°C) ³	With Sustained Loads ⁴	$\tau_{k,uncr}$	psi (N/mm ²)	1,045 (7.2)	1,020 (7.0)	1,010 (7.0)	1,000 (6.9)	1,000 (6.9)	985 (6.8)	975 (6.7)	975 (6.7)
		Short Term Loads only ⁵		psi (N/mm ²)	1,305 (9.0)	1,275 (8.8)	1,260 (8.7)	1,245 (8.6)	1,245 (8.6)	1,235 (8.5)	1,220 (8.4)	1,220 (8.4)
	Maximum Short Term Temperature = 162°F (72°C), Maximum Long Term Temperature = 122°F (50°C) ³	With Sustained Loads ⁴		psi (N/mm ²)	795 (5.5)	780 (5.4)	770 (5.3)	760 (5.2)	760 (5.2)	750 (5.2)	745 (5.1)	745 (5.1)
		Short Term Loads only ⁵		psi (N/mm ²)	1,305 (9.0)	1,275 (8.8)	1,260 (8.7)	1,245 (8.6)	1,245 (8.6)	1,235 (8.5)	1,220 (8.4)	1,220 (8.4)
Characteristic Bond Strength in Cracked Concrete	Maximum Short Term Temperature = 162°F (72°C), Maximum Long Term Temperature = 109°F (43°C) ³	With Sustained Loads ⁴	$\tau_{k,cr}$	psi (N/mm ²)	555 (3.8)	590 (4.1)	615 (4.2)	650 (4.5)	650 (4.5)	650 (4.5)	650 (4.5)	660 (4.6)
		Short Term Loads only ⁵		psi (N/mm ²)	695 (4.8)	740 (5.1)	770 (5.3)	810 (5.6)	810 (5.6)	810 (5.6)	810 (5.6)	825 (5.7)
	Maximum Short Term Temperature = 162°F (72°C), Maximum Long Term Temperature = 122°F (50°C) ³	With Sustained Loads ⁴		psi (N/mm ²)	425 (2.9)	450 (3.1)	470 (3.2)	495 (3.4)	495 (3.4)	495 (3.4)	495 (3.4)	505 (3.5)
		Short Term Loads only ⁵		psi (N/mm ²)	695 (4.8)	740 (5.1)	770 (5.3)	810 (5.6)	810 (5.6)	810 (5.6)	810 (5.6)	825 (5.7)
Reduction Factor for Seismic Tension			$\alpha_{N,seis}$	-	0.97	0.96	0.94	0.93	0.92	0.90	0.88	0.87
Strength Reduction Factors for Permissible Installation Conditions	Dry Holes in Concrete	Continuous Inspection	ϕ_d	-	0.55	0.65	0.55			0.45		
		Periodic Inspection		-	0.55	0.65	0.55			0.45		
	Water Saturated Holes in Concrete	Continuous Inspection	ϕ_{ws}	-	0.65							
		Periodic Inspection		-	0.55	0.65	0.55			0.45		
	Water-filled Holes in Concrete	Continuous Inspection	ϕ_{wf}	-	0.45							
		Periodic Inspection		-	0.45							
	Underwater Installation in Concrete	Continuous Inspection	ϕ_{uw}	-	0.45	0.55						
		Periodic Inspection		-	0.45	0.55						
Modification Factors	Dry Holes in Concrete	Continuous Inspection	K_d	-	1.0						0.98	
		Periodic Inspection		-	1.0						0.98	
	Water Saturated Holes in Concrete	Continuous Inspection	K_{ws}	-	1.0							
		Periodic Inspection		-	1.0						0.98	
	Water-filled Holes in Concrete	Continuous Inspection	K_{wft}	-	0.91	0.95	1.0					
		Periodic Inspection		-	0.89	0.94	0.97	0.95	0.92			

For **SI**: 1 inch = 25.4 mm, 1 lbf = 4.448 N, 1 psi = 0.006897 MPa.

For **pound-inch** units: 1 mm = 0.03937 inches, 1 N = 0.2248 lbf, 1 MPa = 145.0 psi.

¹Characteristic bond strength values correspond to concrete compressive strength $f'_c = 2,500$ psi (17.2 MPa). For uncracked concrete compressive strength f'_c between 2,500 psi (17.2 MPa) and 8,000 psi (55.2 MPa) [minimum of 24 MPa is required under ADIBC Appendix L, Section 5.1.1], the tabulated characteristic bond strength may be increased by factor of $(f'_c / 2,500)^{0.1}$ [for SI: $(f'_c / 17.2)^{0.1}$]. See Section 4.1.4 of this report.

²Lightweight concrete may be used by applying a reduction factor as given in ACI 318-19 17.2.4, ACI 318-14 17.2.6 or ACI 318-11 Appendix D section D.3.6 as applicable.

³Short term elevated concrete temperatures are those that occur over brief intervals, e.g., as a result of diurnal cycling. Long term concrete temperatures are roughly constant over significant periods of time.

⁴Characteristic bond strengths are for sustained loads including dead and live loads.

⁵Characteristic bond strengths are for short-term loads including wind.

TABLE 31—BOND STRENGTH DESIGN INFORMATION FOR FRACTIONAL REINFORCING BAR IN HOLES DRILLED WITH A HAMMER DRILL AND HOLLOW DRILL BIT ^{1,2}

DESIGN INFORMATION			Symbol	Units	Rebar Size						
					#3	#4	#5	#6	#7	#8	#9
Minimum Embedment Depth			$h_{ef,min}$	in. (mm)	2 ³ / ₈ (60)	2 ³ / ₄ (70)	3 ¹ / ₈ (79)	3 ¹ / ₂ (89)	3 ¹ / ₂ (89)	4 (102)	4 ¹ / ₂ (114)
Maximum Embedment Depth			$h_{ef,max}$	in. (mm)	7 ¹ / ₂ (191)	10 (254)	12 ¹ / ₂ (318)	15 (381)	17 ¹ / ₂ (445)	20 (508)	22 ¹ / ₂ (572)
Characteristic Bond Strength in Uncracked Concrete	Maximum Short Term Temperature = 162°F (72°C), Maximum Long Term Temperature = 109°F (43°C) ³	With Sustained Loads ⁴	$\tau_{k,uncr}$	psi (N/mm ²)	1,115 (7.7)	1,135 (7.8)	1,150 (7.9)	1,170 (8.1)	1,195 (8.2)	1,205 (8.3)	1,230 (8.5)
		Short Term Loads only ⁵		psi (N/mm ²)	1,390 (9.6)	1,420 (9.8)	1,435 (9.9)	1,465 (10.1)	1,495 (10.3)	1,510 (10.4)	1,535 (10.6)
	Maximum Short Term Temperature = 162°F (72°C), Maximum Long Term Temperature = 122°F (50°C) ³	With Sustained Loads ⁴		psi (N/mm ²)	850 (5.9)	865 (6.0)	875 (6.0)	895 (6.2)	910 (6.3)	920 (6.3)	940 (6.5)
		Short Term Loads only ⁵		psi (N/mm ²)	1,390 (9.6)	1,420 (9.8)	1,435 (9.9)	1,465 (10.1)	1,495 (10.3)	1,510 (10.4)	1,535 (10.6)
Characteristic Bond Strength in Cracked Concrete	Maximum Short Term Temperature = 162°F (72°C), Maximum Long Term Temperature = 109°F (43°C) ³	With Sustained Loads ⁴	$\tau_{k,cr}$	psi (N/mm ²)	720 (5.0)	755 (5.2)	775 (5.4)	825 (5.7)	860 (5.9)	880 (6.1)	930 (6.4)
		Short Term Loads only ⁵		psi (N/mm ²)	900 (6.2)	945 (6.5)	970 (6.7)	1,030 (7.1)	1,075 (7.4)	1,100 (7.6)	1,160 (8.0)
	Maximum Short Term Temperature = 162°F (72°C), Maximum Long Term Temperature = 122°F (50°C) ³	With Sustained Loads ⁴		psi (N/mm ²)	550 (3.8)	575 (4.0)	595 (4.1)	630 (4.3)	655 (4.5)	670 (4.6)	710 (4.9)
		Short Term Loads only ⁵		psi (N/mm ²)	900 (6.2)	945 (6.5)	970 (6.7)	1,030 (7.1)	1,075 (7.4)	1,100 (7.6)	1,160 (8.0)
Reduction Factor for Seismic Tension			$\alpha_{N,seis}$	-	0.97	0.96	0.94	0.93	0.92	0.90	0.88
Strength Reduction Factors for Permissible Installation Conditions	Dry Holes in Concrete	Continuous Inspection	ϕ_d	-	0.65						0.55
		Periodic Inspection		-	0.65						0.55
	Water Saturated Holes in Concrete	Continuous Inspection	ϕ_{ws}	-	0.65						
		Periodic Inspection		-	0.65						0.55

For **SI**: 1 inch = 25.4 mm, 1 lbf = 4.448 N, 1 psi = 0.006897 MPa.

For **pound-inch** units: 1 mm = 0.03937 inches, 1 N = 0.2248 lbf, 1 MPa = 145.0 psi.

¹Characteristic bond strength values correspond to concrete compressive strength $f_c = 2,500$ psi (17.2 MPa). For uncracked concrete compressive strength f_c between 2,500 psi (17.2 MPa) and 8,000 psi (55.2 MPa) [minimum of 24 MPa is required under ADIBC Appendix L, Section 5.1.1], the tabulated characteristic bond strength may be increased by factor of $(f_c / 2,500)^{0.1}$ [for SI: $(f_c / 17.2)^{0.1}$]. See Section 4.1.4 of this report.

²Lightweight concrete may be used by applying a reduction factor as given in ACI 318-19 17.2.4, ACI 318-14 17.2.6 or ACI 318-11 Appendix D section D.3.6 as applicable.

³Short term elevated concrete temperatures are those that occur over brief intervals, e.g., as a result of diurnal cycling. Long term concrete temperatures are roughly constant over significant periods of time.

⁴Characteristic bond strengths are for sustained loads including dead and live loads.

⁵Characteristic bond strengths are for short-term loads including wind.

TABLE 32—STEEL DESIGN INFORMATION FOR RG M I INTERNAL THREADED (FRACTIONAL) ANCHOR¹

DESIGN INFORMATION	SYMBOL	UNITS	Anchor Fractional Thread Size				
			³ / ₈	¹ / ₂	⁵ / ₈	³ / ₄	
Nominal Anchor Diameter	d_e	in. (mm)	³ / ₈ (9.5)	¹ / ₂ (12.7)	⁵ / ₈ (15.9)	³ / ₄ (19.1)	
Outer Anchor Diameter	d_a	in. (mm)	0.63 (16.0)	0.72 (18.3)	0.88 (22.3)	1.11 (28.3)	
Anchor effective cross-sectional area	A_{se}	in. ² (mm ²)	0.2133 (144.6)	0.2486 (147.9)	0.3185 (209.5)	0.5267 (366.0)	
Anchor ISO 898-1 Grade 5.8 with Bolt: ISO 898-1 Grade 5.8	Nominal strength as governed by steel strength	N_{sa}	lb (kN)	5,620 (25.0)	10,285 (45.8)	16,390 (72.9)	24,255 (107.9)
		V_{sa}	lb (kN)	3,370 (15.0)	6,170 (27.5)	9,835 (43.7)	14,555 (64.7)
	Reduction for seismic shear	$\alpha_{V,seis}$	-	1.0			
	Strength reduction factor ϕ for tension ²	ϕ	-	0.65			
	Strength reduction factor ϕ for shear ²	ϕ	-	0.60			
Anchor: ISO 898-1 Grade 8.8 with Bolt: ISO 898-1 Grade 8.8	Nominal strength as governed by steel strength	N_{sa}	lb (kN)	8,990 (40.0)	16,455 (73.2)	24,725 (110.0)	38,810 (172.6)
		V_{sa}	lb (kN)	5,395 (24.0)	9,875 (43.9)	15,735 (70.0)	23,285 (103.6)
	Reduction for seismic shear	$\alpha_{V,seis}$	-	0.90		-	0.90
	Strength reduction factor ϕ for tension ²	ϕ	-	0.65			
	Strength reduction factor ϕ for shear ²	ϕ	-	0.60			
Anchor / Bolt ISO 3506-1 Grade 70 and HCR Grade 70	Nominal strength as governed by steel strength	N_{sa}	lb (kN)	7,870 (35.0)	14,400 (64.1)	22,945 (102.1)	33,960 (151.1)
		V_{sa}	lb (kN)	4,720 (21.0)	8,640 (38.4)	13,765 (61.2)	20,375 (90.6)
	Reduction for seismic shear	$\alpha_{V,seis}$	-	0.90			
	Strength reduction factor ϕ for tension ²	ϕ	-	0.65			
	Strength reduction factor ϕ for shear ²	ϕ	-	0.60			

For **SI**: 1 inch = 25.4 mm, 1 lbf = 4.448 N, 1 psi = 0.006897 MPa.

For **pound-inch** units: 1 mm = 0.03937 inches, 1 N = 0.2248 lbf, 1 MPa = 145.0 psi.

¹Values provided for common rod material types are based on specified strength and calculated in accordance with ACI 318-19 Eq. 17.6.1.2, ACI 318-14 Eq. 17.4.1.2 and Eq. 17.5.1.2b or ACI 318-11 Eq. D-2 and Eq. D-29, as applicable.

²For use with load combinations Section 1605.1 of the 2021 IBC, Section 1605.2 of the 2018, 2015, 2012 and 2009 IBC, ACI 318-19 and ACI 318-14 5.3 or ACI 318-11 9.2, as applicable, as set forth in ACI 318-14 17.3.3 or ACI 318-11 D.4.3, as applicable. If the load combinations of ACI 318-11 Appendix C are used, the appropriate value of ϕ must be determined in accordance with ACI 318-11 D.4.4. Values correspond to a brittle steel element.

TABLE 33—CONCRETE BREAKOUT DESIGN INFORMATION FOR RG M I INTERNAL THREADED (FRACTIONAL) ANCHOR

DESIGN INFORMATION		SYMBOL	UNITS	Anchor Fractional Threaded Size			
				³ / ₈	¹ / ₂	⁵ / ₈	³ / ₄
Embedment Depth		h_{ef}	in (mm)	3.54 (90)	4.92 (125)	6.30 (160)	7.87 (200)
Effectiveness Factor	Uncracked Concrete	$k_{c,uncr}$	in.lb (SI)	24 (10)			
	Cracked Concrete	$k_{c,cr}$	in.lb (SI)	17 (7.1)			
Minimum Value	Anchor Spacing	s_{min}	in. (mm)	$s_{min} = c_{min}$			
	Edge Distance	c_{min}	in. (mm)	2.56 (65)	2.95 (75)	3.74 (95)	4.92 (125)
	Member Thickness	h_{min}	in. (mm)	125 (4.92)	165 (6.50)	205 (8.07)	260 (10.24)
Critical Value	Edge Distance for Splitting Failure	c_{ac}	in. (mm)	See Section 4.1.10 of this report			
Strength reduction factor ϕ , concrete failure modes, Condition B ¹	Tension	ϕ	-	0.65			
	Shear	ϕ	-	0.70			

For **SI**: 1 inch = 25.4 mm, 1 lbf = 4.448 N, 1 psi = 0.006897 MPa.

For **pound-inch** units: 1 mm = 0.03937 inches, 1 N = 0.2248 lbf, 1 MPa = 145.0 psi.

¹Values provided for post-installed anchors with category as determined from ACI 355.4 given for Condition B. Condition B applies without supplementary reinforcement or where pullout (bond) or pryout govern, as set forth in ACI 318-19 17.5.3, ACI 318-14 17.3.3 or ACI 318-11 D.4.3, as applicable, while condition A requires supplemental reinforcement. Values are for use with load combinations Section 1605.1 of the 2021 IBC, Section 1605.2 of the 2018, 2015, 2012 and 2009 IBC, ACI 318-19 and ACI 318-14 5.3 or ACI 318-11 9.2, as applicable, as set forth in ACI 318-19 17.5.3, ACI 318-14 17.3.3 or ACI 318-11 D.4.3, as applicable. If the load combinations of ACI 318-11 Appendix C are used, the appropriate value of ϕ must be determined in accordance with ACI 318-11 D.4.4.

TABLE 34—BOND STRENGTH DESIGN INFORMATION FOR RG M I INTERNAL THREADED (FRACTIONAL) ANCHOR IN HOLES DRILLED WITH A HAMMER DRILL and CARBIDE BIT ^{1,2}

DESIGN INFORMATION			Symbol	Units	Anchor Fractional Thread Size (inch)			
					³ / ₈	¹ / ₂	⁵ / ₈	³ / ₄
Embedment Depth			h_{ef}	in. (mm)	3.54 (90)	4.92 (125)	6.30 (160)	7.87 (200)
Characteristic Bond Strength in Uncracked Concrete	Maximum Short Term Temperature = 162°F (72°C), Maximum Long Term Temperature = 109°F (43°C) ³	With Sustained Loads ⁴	$f_{k,uncr}$	psi (N/mm ²)	2,170 (15.0)	2,125 (14.6)	2,040 (14.1)	1,960 (13.5)
		Short Term Loads only ⁵		psi (N/mm ²)	2,710 (18.7)	2,655 (18.3)	2,555 (17.6)	2,450 (16.9)
	Maximum Short Term Temperature = 162°F (72°C), Maximum Long Term Temperature = 122°F (50°C) ³	With Sustained Loads ⁴		psi (N/mm ²)	1,655 (11.4)	1,620 (11.2)	1,555 (10.7)	1,495 (10.3)
		Short Term Loads only ⁵		psi (N/mm ²)	2,710 (18.7)	2,655 (18.3)	2,555 (17.6)	2,450 (16.9)
Characteristic Bond Strength in Cracked Concrete	Maximum Short Term Temperature = 162°F (72°C), Maximum Long Term Temperature = 109°F (43°C) ³	With Sustained Loads ⁴	$f_{k,cr}$	psi (N/mm ²)	1,345 (9.3)	1,325 (9.1)	1,310 (9.0)	1,300 (9.0)
		Short Term Loads only ⁵		psi (N/mm ²)	1,680 (11.6)	1,655 (11.4)	1,640 (11.3)	1,625 (11.2)
	Maximum Short Term Temperature = 162°F (72°C), Maximum Long Term Temperature = 122°F (50°C) ³	With Sustained Loads ⁴		psi (N/mm ²)	1,025 (7.1)	1,010 (7.0)	1,000 (6.9)	990 (6.8)
		Short Term Loads only ⁵		psi (N/mm ²)	1,680 (11.6)	1,655 (11.4)	1,640 (11.3)	1,625 (11.2)
Reduction Factor for Seismic Tension			$\alpha_{N,seis}$	-	0.94	0.93	0.91	0.88
Strength Reduction Factors for Permissible Installation Conditions	Dry Holes in Concrete	Continuous Inspection	ϕ_d	-	0.65	0.55		
		Periodic Inspection		-	0.65	0.55		
	Water Saturated Holes in Concrete	Continuous Inspection	ϕ_{ws}	-	0.65			
		Periodic Inspection		-	0.65			
	Water-filled Holes in Concrete	Continuous Inspection	ϕ_{wf}	-	0.45			
		Periodic Inspection		-	0.45			
	Underwater Installation in Concrete	Continuous Inspection	ϕ_{uw}	-	0.55			
		Periodic Inspection		-	0.55			
Modification Factors	Water-filled Holes in Concrete	Continuous Inspection	K_{wf}	-	0.92	0.91	0.89	0.85
		Periodic Inspection		-	0.83	0.82	0.80	0.77

For **SI**: 1 inch = 25.4 mm, 1 lbf = 4.448 N, 1 psi = 0.006897 MPa.

For **pound-inch** units: 1 mm = 0.03937 inches, 1 N = 0.2248 lbf, 1 MPa = 145.0 psi.

¹Characteristic bond strength values correspond to concrete compressive strength $f'_c = 2,500$ psi (17.2 MPa). For uncracked concrete compressive strength f'_c between 2,500 psi (17.2 MPa) and 8,000 psi (55.2 MPa) [minimum of 24 MPa is required under ADIBC Appendix L, Section 5.1.1], the tabulated characteristic bond strength may be increased by factor of $(f'_c / 2,500)^{0.1}$ [for SI: $(f'_c / 17.2)^{0.1}$]. See Section 4.1.4 of this report.

²Lightweight concrete may be used by applying a reduction factor as given in ACI 318-19 17.2.4, ACI 318-14 17.2.6 or ACI 318-11 Appendix D section D.3.6 as applicable.

³Short term elevated concrete temperatures are those that occur over brief intervals, e.g., as a result of diurnal cycling. Long term concrete temperatures are roughly constant over significant periods of time.

⁴Characteristic bond strengths are for sustained loads including dead and live loads.

⁵Characteristic bond strengths are for short-term loads including wind.

TABLE 35—BOND STRENGTH DESIGN INFORMATION FOR RG M I INTERNAL THREADED (FRACTIONAL) ANCHOR IN HOLES DRILLED WITH A DIAMOND CORE BIT ^{1,2}

DESIGN INFORMATION			Symbol	Units	Anchor Fractional Thread Size (inch)			
					³ / ₈	¹ / ₂	⁵ / ₈	³ / ₄
Embedment Depth			h_{ef}	in. (mm)	3.54 (90)	4.92 (125)	6.30 (160)	7.87 (200)
Characteristic Bond Strength in Uncracked Concrete	Maximum Short Term Temperature = 162°F (72°C), Maximum Long Term Temperature = 109°F (43°C) ³	With Sustained Loads ⁴	$\bar{t}_{k,uncr}$	psi (N/mm ²)	1,425 (9.8)	1,370 (9.4)	1,290 (8.9)	1,195 (8.2)
		Short Term Loads only ⁵		psi (N/mm ²)	1,785 (12.3)	1,710 (11.8)	1,610 (11.1)	1,495 (10.3)
	Maximum Short Term Temperature = 162°F (72°C), Maximum Long Term Temperature = 122°F (50°C) ³	With Sustained Loads ⁴		psi (N/mm ²)	1,090 (7.5)	1,045 (7.2)	980 (6.8)	910 (6.3)
		Short Term Loads only ⁵		psi (N/mm ²)	1,785 (12.3)	1,710 (11.8)	1,610 (11.1)	1,495 (10.3)
Characteristic Bond Strength in Cracked Concrete	Maximum Short Term Temperature = 162°F (72°C), Maximum Long Term Temperature = 109°F (43°C) ³	With Sustained Loads ⁴	$\bar{t}_{k,cr}$	psi (N/mm ²)	975 (6.7)	1,000 (6.9)	965 (6.6)	940 (6.5)
		Short Term Loads only ⁵		psi (N/mm ²)	1,220 (8.4)	1,245 (8.6)	1,205 (8.3)	1,175 (8.1)
	Maximum Short Term Temperature = 162°F (72°C), Maximum Long Term Temperature = 122°F (50°C) ³	With Sustained Loads ⁴		psi (N/mm ²)	745 (5.1)	760 (5.2)	735 (5.1)	715 (4.9)
		Short Term Loads only ⁵		psi (N/mm ²)	1,220 (8.4)	1,245 (8.6)	1,205 (8.3)	1,175 (8.1)
Reduction Factor for Seismic Tension			$\alpha_{N,seis}$	-	0.94	0.93	0.91	0.88
Strength Reduction Factors for Permissible Installation Conditions	Dry Holes in Concrete	Continuous Inspection	ϕ_d	-	0.65		0.55	0.45
		Periodic Inspection		-	0.65		0.55	0.45
	Water Saturated Holes in Concrete	Continuous Inspection	ϕ_{ws}	-	0.65			
		Periodic Inspection		-	0.65		0.55	0.45
	Water-filled Holes in Concrete	Continuous Inspection	ϕ_{wf}	-	0.45			
		Periodic Inspection		-	0.45			
	Underwater Installation in Concrete	Continuous Inspection	ϕ_{uw}	-	0.55			
		Periodic Inspection		-	0.55			
Modification Factors in Concrete	Water-filled Holes in Concrete	Continuous Inspection	K_{wf}	-	1.0			
		Periodic Inspection		-	0.95	0.97		0.95

For **SI**: 1 inch = 25.4 mm, 1 lbf = 4.448 N, 1 psi = 0.006897 MPa.

For **pound-inch** units: 1 mm = 0.03937 inches, 1 N = 0.2248 lbf, 1 MPa = 145.0 psi.

¹Characteristic bond strength values correspond to concrete compressive strength $f'_c = 2,500$ psi (17.2 MPa). For uncracked concrete compressive strength f'_c between 2,500 psi (17.2 MPa) and 8,000 psi (55.2 MPa) [minimum of 24 MPa is required under ADIBC Appendix L, Section 5.1.1], the tabulated characteristic bond strength may be increased by factor of $(f'_c / 2,500)^{0.1}$ [for SI: $(f'_c / 17.2)^{0.1}$]. See Section 4.1.4 of this report.

²Lightweight concrete may be used by applying a reduction factor as given in ACI 318-19 17.2.4, ACI 318-14 17.2.6 or ACI 318-11 Appendix D section D.3.6 as applicable.

³Short term elevated concrete temperatures are those that occur over brief intervals, e.g., as a result of diurnal cycling. Long term concrete temperatures are roughly constant over significant periods of time.

⁴Characteristic bond strengths are for sustained loads including dead and live loads.

⁵Characteristic bond strengths are for short-term loads including wind.

TABLE 36—BOND STRENGTH DESIGN INFORMATION FOR RG M I INTERNAL THREADED (FRACTIONAL) ANCHOR IN HOLES DRILLED WITH A HAMMER AND HOLLOW DRILL BIT ^{1,2}

DESIGN INFORMATION			Symbol	Units	Anchor Fractional Thread Size (inch)			
					³ / ₈	¹ / ₂	⁵ / ₈	³ / ₄
Embedment Depth			h_{ef}	in. (mm)	3.54 (90)	4.92 (125)	6.30 (160)	7.87 (200)
Characteristic Bond Strength in Uncracked Concrete	Maximum Short Term Temperature = 162°F (72°C), Maximum Long Term Temperature = 109°F (43°C) ³	With Sustained Loads ⁴	$\tau_{k,uncr}$	psi (N/mm ²)	2,005 (13.8)	1,950 (13.4)	1,855 (12.8)	1,750 (12.1)
		Short Term Loads only ⁵		psi (N/mm ²)	2,510 (17.3)	2,435 (16.8)	2,320 (16.0)	2,190 (15.1)
	Maximum Short Term Temperature = 162°F (72°C), Maximum Long Term Temperature = 122°F (50°C) ³	With Sustained Loads ⁴		psi (N/mm ²)	1,530 (10.6)	1,485 (10.2)	1,415 (9.8)	1,335 (9.2)
		Short Term Loads only ⁵		psi (N/mm ²)	2,510 (17.3)	2,435 (16.8)	2,320 (16.0)	2,190 (15.1)
Characteristic Bond Strength in Cracked Concrete	Maximum Short Term Temperature = 162°F (72°C), Maximum Long Term Temperature = 109°F (43°C) ³	With Sustained Loads ⁴	$\tau_{k,cr}$	psi (N/mm ²)	1,310 (9.0)	1,290 (8.9)	1,275 (8.8)	1,275 (8.8)
		Short Term Loads only ⁵		psi (N/mm ²)	1,640 (11.3)	1,610 (11.1)	1,595 (11.0)	1,595 (11.0)
	Maximum Short Term Temperature = 162°F (72°C), Maximum Long Term Temperature = 122°F (50°C) ³	With Sustained Loads ⁴		psi (N/mm ²)	1,000 (6.9)	980 (6.8)	975 (6.7)	975 (6.7)
		Short Term Loads only ⁵		psi (N/mm ²)	1,640 (11.3)	1,610 (11.1)	1,595 (11.0)	1,595 (11.0)
Reduction Factor for Seismic Tension			$\alpha_{N,seis}$	-	0.94	0.93	0.91	0.88
Strength Reduction Factors for Permissible Installation Conditions	Dry Holes in Concrete	Continuous Inspection	ϕ_d	-	0.65			0.55
		Periodic Inspection		-	0.65			0.55
	Water Saturated Holes in Concrete	Continuous Inspection	ϕ_{ws}	-	0.65			
		Periodic Inspection		-	0.65			

For **SI**: 1 inch = 25.4 mm, 1 lbf = 4.448 N, 1 psi = 0.006897 MPa.

For **pound-inch** units: 1 mm = 0.03937 inches, 1 N = 0.2248 lbf, 1 MPa = 145.0 psi.

¹Characteristic bond strength values correspond to concrete compressive strength $f_c = 2,500$ psi (17.2 MPa). For uncracked concrete compressive strength f_c between 2,500 psi (17.2 MPa) and 8,000 psi (55.2 MPa) [minimum of 24 MPa is required under ADIBC Appendix L, Section 5.1.1], the tabulated characteristic bond strength may be increased by factor of $(f_c / 2,500)^{0.1}$ [for SI: $(f_c / 17.2)^{0.1}$]. See Section 4.1.4 of this report.

²Lightweight concrete may be used by applying a reduction factor as given in ACI 318-19 17.2.4, ACI 318-14 17.2.6 or ACI 318-11 Appendix D section D.3.6 as applicable.

³Short term elevated concrete temperatures are those that occur over brief intervals, e.g., as a result of diurnal cycling. Long term concrete temperatures are roughly constant over significant periods of time.

⁴Characteristic bond strengths are for sustained loads including dead and live loads.

⁵Characteristic bond strengths are for short-term loads including wind.

TABLE 37—DEVELOPMENT LENGTH FOR EU METRIC REINFORCING BARS^{1, 2, 3, 4, 5, 6}

DESIGN INFORMATION			Symbol	Units	Rebar size						
					10	12	16	20	25	28	32
Nominal Bar Diameter			d_b	mm (in.)	10 (0.39)	12 (0.47)	16 (0.63)	20 (0.79)	25 (0.98)	28 (1.10)	32 (1.26)
Bar effective cross-sectional area			A_{se}	mm ² (in. ²)	78.5 (0.122)	113.0 (0.175)	201.0 (0.312)	314.0 (0.487)	491.0 (0.761)	616.0 (0.955)	804.0 (1.246)
Development length for	DIN 488 B500B	Concrete Compressive Strength $f'_c = 2,500$ psi (17.2 MPa) (normal weight concrete) ³	l_d	mm	348	418	557	870	1,088	1,218	1,392
				(in.)	(13.7)	(16.4)	(21.9)	(34.3)	(42.8)	(48.0)	(54.8)
	DIN 488 B500B	Concrete Compressive Strength $f'_c = 4,000$ psi (27.6 MPa) (normal weight concrete) ³		mm	305	330	440	688	860	963	1,101
				(in.)	(12.0)	(13.0)	(17.3)	(27.1)	(33.9)	(37.9)	(43.3)

For **SI**: 1 inch = 25.4 mm, 1 lbf = 4.448 N, 1 psi = 0.006897 MPa.

For **pound-inch** units: 1 mm = 0.03937 inches, 1 N = 0.2248 lbf, 1 MPa = 145.0 psi.

¹Development lengths valid for static, wind and seismic loads (SDC A and B)

²Development lengths in SDC C through F must comply with ACI 318-19 and ACI 318-14 Chapter 18 or ACI 318-11 Chapter 21 and section 4.2.4. of this report.

³For sand-lightweight concrete, increase development length by 33%, unless the provisions of ACI 318-19 25.4.2.5, ACI 318-14 25.4.2.4 or ACI 318-11 12.2.4 (d), as applicable, are met to permit $\lambda > 0.75$

⁴ $\left(\frac{c_b + K_{tr}}{d_b}\right) = 2.5$, $\psi_t = 1.0$, $\psi_e = 1.0$, $\psi_s = 0.8$ for $d_b \leq 20$ mm, $\psi_s = 1.0$ for $d_b > 20$ mm

⁵Minimum f'_c of 24 MPa is required under ADIBC Appendix L, Section 5.1.1

⁶Calculations may be performed for other steel grades per ACI 318-11 Chapter 12 or ACI 318-14 and ACI 318-19 Chapter 25

TABLE 38—DEVELOPMENT LENGTH FOR U.S. CUSTOMARY UNIT REINFORCING BARS^{1, 2, 3, 4, 5, 6}

DESIGN INFORMATION			Symbol	Units	Rebar size								
					#3	#4	#5	#6	#7	#8	#9	#10	#11
Nominal reinforcing bar diameter			d_b	in. (mm)	$\frac{3}{8}$ (9.5)	$\frac{1}{2}$ (12.7)	$\frac{5}{8}$ (15.9)	$\frac{3}{4}$ (19.1)	$\frac{7}{8}$ (22.2)	1 (25.4)	$1\frac{1}{8}$ (28.6)	$1\frac{1}{4}$ (31.8)	$1\frac{3}{8}$ (34.9)
Nominal bar area			A_{se}	in. ² (mm ²)	0.11 (71.0)	0.20 (129.0)	0.31 (199.0)	0.44 (284.0)	0.60 (387.0)	0.79 (510.0)	1.00 (645.0)	1.27 (819.0)	1.56 (1,006.0)
Development length for	ASTM A615 Grade 40	Concrete Compressive Strength $f'_c = 2,500$ psi (17.2 MPa) (normal weight concrete) ³	l_d	in.	12.0	12.0	12.0	14.4	21.0	24.0	27.0	30.0	33.0
				(mm)	(305)	(305)	(305)	(366)	(533)	(610)	(686)	(762)	(838)
	ASTM A615 / A706 Grade 60	Concrete Compressive Strength $f'_c = 2,500$ psi (17.2 MPa) (normal weight concrete) ³		in.	12.0	14.4	18.0	21.6	31.5	36.0	40.5	45.0	49.5
				(mm)	(305)	(366)	(457)	(549)	(800)	(914)	(1,029)	(1,143)	(1,257)
	ASTM A615 Grade 40	Concrete Compressive Strength $f'_c = 4,000$ psi (27.6 MPa) (normal weight concrete) ³		in.	12.0	12.0	12.0	12.0	16.6	19.0	21.3	23.7	26.1
				(mm)	(305)	(305)	(305)	(305)	(422)	(482)	(542)	(602)	(663)
	ASTM A615 / A706 Grade 60	Concrete Compressive Strength $f'_c = 4,000$ psi (27.6 MPa) (normal weight concrete) ³		in.	12.0	12.0	14.2	17.1	24.9	28.5	32.0	35.6	39.1
				(mm)	(305)	(305)	(361)	(434)	(633)	(723)	(813)	(904)	(994)

For **SI**: 1 inch = 25.4 mm, 1 lbf = 4.448 N, 1 psi = 0.006897 MPa.

For **pound-inch** units: 1 mm = 0.03937 inches, 1 N = 0.2248 lbf, 1 MPa = 145.0 psi.

¹Development lengths valid for static, wind and seismic loads (SDC A and B)

²Development lengths in SDC C through F must comply with ACI 318-19 and ACI 318-14 Chapter 18 or ACI 318-11 Chapter 21, as applicable, and section 4.2.4. of this report





³For sand-lightweight concrete, increase development length by 33%, unless the provisions of ACI 318-19 25.4.2.5, ACI 318-14 25.4.2.4 or ACI 318-11 12.2.4 (d), as applicable, are met to permit $\lambda > 0.75$

⁴ $\left(\frac{c_b + K_{tr}}{d_b}\right) = 2.5$, $\psi_t = 1.0$, $\psi_e = 1.0$, $\psi_s = 0.8$ for $d_b \leq \#6$, $\psi_s = 1.0$ for $d_b > \#6$

⁵Minimum f'_c of 24 MPa is required under ADIBC Appendix L, Section 5.1.1

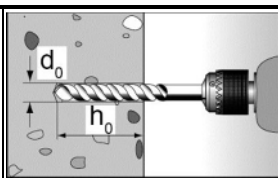
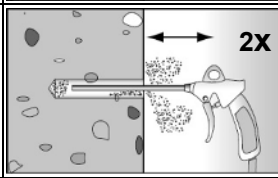
⁶Calculations may be performed for other steel grades per ACI 318-11 Chapter 12 or ACI 318-14 and ACI 318-19 Chapter 25

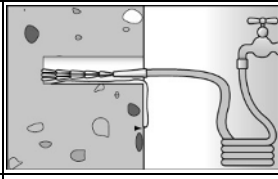
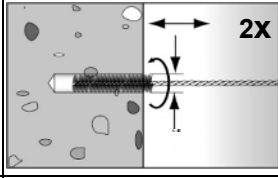
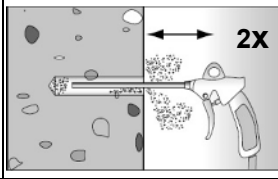
Drilling and cleaning the hole (hammer drilling with standard drill bit)

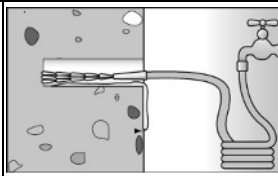
1		<p>Drill the hole. Nominal drill hole diameter d_0 and drill hole depth h_0 see Tables II, III, IV or VI, VII, VIII respectively.</p>	
2a		<p>Cleaning of the drill hole (not applicable for underwater installation): Blow out the drill hole twice, with oil free compressed air ($p \geq 6 \text{ bar} / 87 \text{ psi}$).</p>	
2b		<p>For underwater installation only: Flush the drill hole with clean water until it flows clear.</p>	
3		<p>Brush the drill hole at least twice, brush type see Table I or V respectively. For drill hole diameter $\geq 30 \text{ mm} / 1\frac{1}{2} \text{ in.}$ use a power drill. For deep holes use an extension.</p>	
4a		<p>Cleaning of the drill hole (not applicable for underwater installation): Blow out the drill hole at least twice, with oil free compressed air ($p \geq 6 \text{ bar} / 87 \text{ psi}$).</p>	
4b		<p>For underwater installation only: Flush the drilled hole with clean water until it flows clear.</p>	

Go to step 6

Drilling and cleaning the hole (hammer drilling with hollow drill bit)

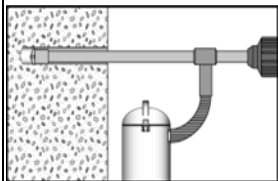
1		<p>Check a suitable hollow drill for correct operation of the dust extraction.</p>
2		<p>Use a suitable dust extraction system, e. g. fischer FVC 35 M or a comparable dust extraction system with at least equivalent performance data (volume flow at the hose end $\geq 36 \text{ l/s} / 1.27 \text{ cfs}$).</p> <p>Drill the hole with hollow drill bit. The dust extraction system has to extract the drill dust nonstop during the drilling process and must be adjusted to maximum power. Nominal drill hole diameter d_0 and drill hole depth h_0 see Tables II, III, IV or VI, VII, VIII respectively.</p>

Go to step 6

FIGURE 6—FIS EM PLUS INSTALLATION INFORMATION

Drilling and cleaning the hole (wet drilling with diamond drill bit)

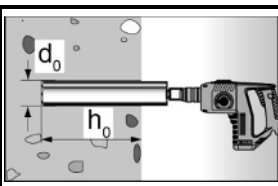
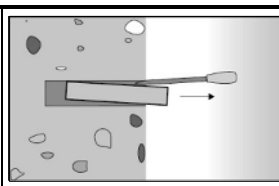
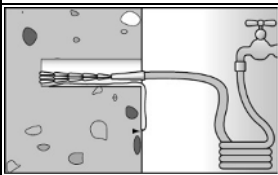
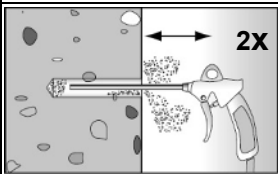
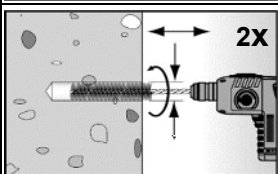
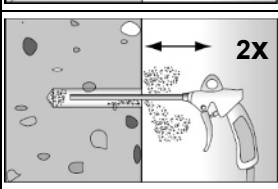
1		<p>Drill the hole. Drill hole diameter d_0 and nominal drill hole depth h_0 see Tables II, III, IV or VI, VII, VIII respectively.</p>		<p>Break the drill core and remove it.</p>
2		<p>Flush the drill hole with clean water until it flows clear.</p>		
3		<p>Blow out the drill hole at least twice, using oil-free compressed air ($p \geq 6 \text{ bar} / 87 \text{ psi}$).</p>		
4		<p>Brush the drill hole at least twice using a power drill, brush type see Table I or V respectively.</p>		
5		<p>Blow out the drill hole at least twice, using oil-free compressed air ($p \geq 6 \text{ bar} / 87 \text{ psi}$).</p>		

Preparing the cartridge

6		<p>Remove the sealing cap. Screw on the static mixer (the spiral in the static mixer must be clearly visible).</p>		
7			<p>Place the cartridge into the dispenser.</p>	
8			<p>Extrude approximately 10 cm / 4 in. of material out until the resin is evenly grey in colour. Do not inject mortar that is not uniformly grey.</p>	

FIGURE 6—FIS EM PLUS INSTALLATION INFORMATION (Continued)

Injection of the mortar

<p>9</p>	 <p>Fill approximately 2/3 of the drilled hole with mortar. Always begin from the bottom of the hole and avoid air pockets or voids.</p>	 <p>For drill hole depth ($h_0 \geq 150$ mm / 6 in.) use an extension tube.</p>	 <p>For overhead installation, deep holes ($h_0 > 250$ mm / 10 in.) or drill hole diameter ($d_0 \geq 40$ mm / 1 1/2 in.) use an injection-adaptor see Table I or V respectively.</p>
----------	---	--	---

Installation of anchor rods or fischer internal threaded anchor

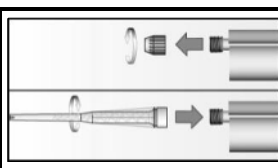
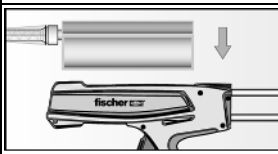
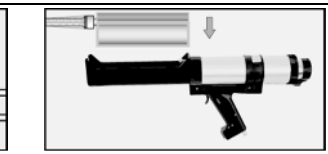
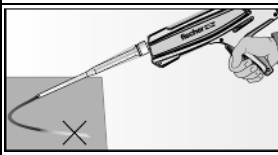
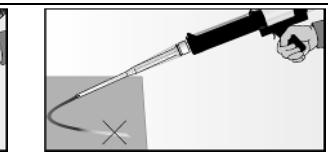
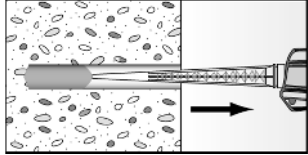
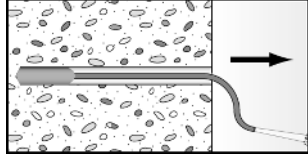
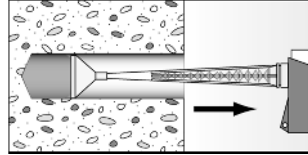

<p>10</p>		<p>Only use clean and oil-free metal parts. Mark the setting depth on the anchor rod. Push the anchor rod or fischer internal threaded anchor RG M I down to the bottom of the hole, turning it slightly while doing so. After inserting the anchor element, excess mortar must be emerged around the anchor element.</p>
<p>11</p>	 <p>For overhead installations support the anchor element with wedges (e. g. fischer centering wedges) or fischer overhead clips.</p>	 <p>For push through installation fill the annular gap with mortar.</p>
<p>11</p>	 <p>Wait for the specified curing time t_{cure} see Table IX.</p>	<p>12</p>  <p>Mounting the fixture $\max T_{inst}$ see Tables II, IV or VI, VIII respectively.</p>
<p>Option</p>		<p>After the minimum curing time is reached, the gap between anchor element and fixture (annular clearance) may be filled with mortar via the fischer filling disc FFD. Compressive strength ≥ 50 N/mm² / 7250 psi (e.g. fischer injection mortars FIS HB, FIS SB, FIS V Plus, FIS EM Plus) ATTENTION: Using fischer filling disk FFD reduces t_{fix} (usable length of the anchor).</p>

FIGURE 6—FIS EM PLUS INSTALLATION INFORMATION (Continued)

Installation reinforcing bars

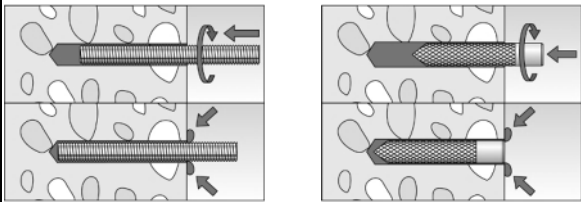
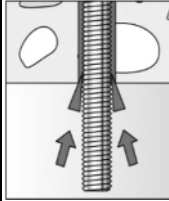
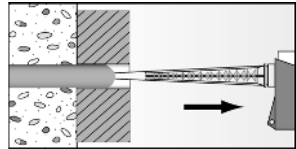

<p>10</p>	 <p>Only use clean and oil-free reinforcing bars. Mark the setting depth. Turn while using force to push the reinforcement bar into the filled hole up to the setting depth mark.</p>
	 <p>When the setting depth mark is reached, excess mortar must be emerged from the mouth of the drill hole.</p>
<p>11</p>	 <p>Wait for the specified curing time t_{cure} see Table IX.</p>

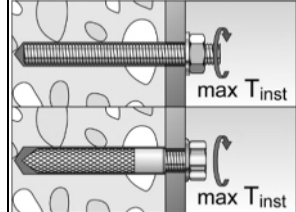
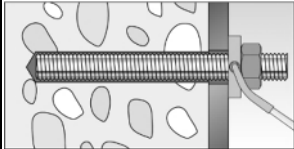
FIGURE 6—FIS EM PLUS INSTALLATION INFORMATION (Continued)

Table I. Drill hole diameter / Accessories for metric sizes

Drill bit		Rods	Rebar	Internal rods	Brush		Injection adapter	
Ø [inch]	Ø [mm]	Ø [mm]	Ø [mm]	Ø [mm]	Type	Item. No.	Size	Color
3/8	10	M8	-	-	BS10	78178	-	-
7/16	12	M10	-	-	BS12	78179	12	nature
9/16	14	M12	10	RG M8 I	BS14	78180	14	blue
5/8	16	-	12	-	BS 16/18	78181	16	red
3/4	18	M16	-	RG M10 I	BS 16/18	78181	18	yellow
13/16	20	-	16	RG M12 I	BS 20	52277	20	green
1	24	M20	-	RG M16 I	BS 24	78182	24	brown
1	25	-	20	-	BS 25	97806	25	black
1 1/8	28	M24	-	-	BS 28	78183	28	blue
1 1/4	30	M27	25	-	BS 35	78184	30	grey
1 1/4	32	-	-	RG M20 I	BS 35	78184	30	grey
1 3/8	35	M30	28	-	BS 35	78184	35	brown
1 1/2	40	-	32	-	BSB 40	505061	40	red

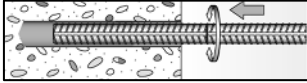
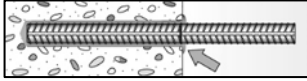
Table II. Metric threaded rods

d _a [mm]	d ₀ [mm]	d ₀ [inch]	h _{ef,min} [mm]	h _{ef,min} [inch]	h _{ef,max} [mm]	h _{ef,max} [inch]	h _{min} [mm]	h _{min} [inch]	S _{min} = C _{min} [mm]	S _{min} = C _{min} [inch]	max T _{inst} [Nm]	max T _{inst} [ft · lb]
M8	10	3/8	60	2,36	160	6,30	h _{ef} + 30 (≥100)	h _{ef} + 1,25 (≥4)	40	1,57	10	7
M10	12	7/16	60	2,36	200	7,87			45	1,77	20	15
M12	14	9/16	70	2,76	240	9,45			55	2,17	40	30
M16	18	3/4	80	3,15	320	12,60	h _{ef} + 2d ₀	h _{ef} + 2d ₀	65	2,56	60	44
M20	24	1	90	3,54	400	15,75			85	3,35	120	89
M24	28	1 1/8	96	3,78	480	18,90			105	4,13	150	111
M27	30	1 1/4	108	4,25	540	21,26			120	4,72	200	148
M30	35	1 3/8	120	4,72	600	23,62			140	5,51	300	221

Table III. Metric reinforcing bars

d _a / d ₀ [mm]	d ₀ [mm]	d ₀ [inch]	h _{ef,min} [mm]	h _{ef,min} [inch]	h _{ef,max} [mm]	h _{ef,max} [inch]	h _{min} [mm]	h _{min} [inch]	S _{min} = C _{min} [mm]	S _{min} = C _{min} [inch]	max T _{inst} ¹ [Nm]	max T _{inst} ¹ [ft · lb]
10	14	9/16	60	2,36	200	7,87	h _{ef} + 30 (≥100)	h _{ef} + 1,25 (≥4)	45	1,77	30	22
12	16	5/8	70	2,76	240	9,45			55	2,17	50	37
16	20	13/16	80	3,15	320	12,60			65	2,56	110	81
20	25	1	90	3,54	400	15,75	h _{ef} + 2d ₀	h _{ef} + 2d ₀	85	3,35	190	140
25	30	1 1/4	100	3,94	500	19,69			120	4,72	280	207
28	35	1 3/8	112	4,41	560	22,05			140	5,51	350	258
32	40	1 1/2	128	5,04	640	25,20			160	6,30	430	317

¹Torque moment only required when using threaded reinforcing bars to resist seismic loading

Table IV. Metric internal threaded anchor

d _e [mm]	d _a [mm]	d _a [inch]	d ₀ [mm]	d ₀ [inch]	h _{ef} [mm]	h _{ef} [inch]	h _{min} [mm]	h _{min} [inch]	S _{min} = C _{min} [mm]	S _{min} = C _{min} [inch]	max T _{inst} [Nm]	max T _{inst} [ft · lb]
RG M8 I	12	1/2	14	9/16	90	3,54	120	4,72	55	2,17	10	7
RG M10 I	16	5/8	18	3/4	90	3,54	125	4,92	65	2,56	20	15
RG M12 I	18	11/16	20	13/16	125	4,92	165	6,50	75	2,95	40	30
RG M16 I	22	7/8	24	1	160	6,30	205	8,07	95	3,74	80	59
RG M20 I	28	1 1/8	32	1 1/4	200	7,87	260	10,24	125	4,92	120	89

FIGURE 6—FIS EM PLUS INSTALLATION INFORMATION (Continued)

Table V. Drill hole diameter / Accessories for fractional sizes

Drill bit		Rods	Rebar	Internal anchor	Brush		Injection adapter	
Ø [inch]	Ø [mm]	Ø [mm]	Ø [mm]	Ø [mm]	Type	Item. No.	Size	Color
7/16	12	3/8	-	-	BS12	78179	-	-
1/2	14	-	#3	-	BS14	78180	12	nature
9/16	15	1/2	-	-	BS14	78180	14	blue
5/8	16	-	#4	-	BS 16/18	78181	16	red
3/4	18	5/8	-	RG MI 3/8	BS 16/18	78181	18	yellow
13/16	20	-	#5	RG MI 1/2	BS 20	52277	20	green
7/8	22	3/4	#6	-	BS 20	52277	20	green
1	25	7/8	-	RG MI 5/8	BS 25	97806	25	black
1 1/8	28	1	#7	-	BS 28	78183	28	blue
1 1/4	32	1 1/8	#8	RG MI 3/4	BS 35	78184	30	grey
1 3/8	35	1 1/4	#9	-	BS 35	78184	35	brown
1 1/2	40	-	#10	-	BSB 40	505061	40	red
1 3/4	45	-	#11	-	BSB 45	506254	45	yellow

Table VI. Fractional threaded rods

d _a [inch]	d ₀ [mm]	d ₀ [inch]	h _{ef,min} [mm]	h _{ef,min} [inch]	h _{ef,max} [mm]	h _{ef,max} [inch]	h _{min} [mm]	h _{min} [inch]	S _{min} = C _{min} [mm]	S _{min} = C _{min} [inch]	max T _{inst} [Nm]	max T _{inst} [ft · lb]
3/8	12	7/16	60	2 3/8	191	7 1/2	hef + 30 (≥100)	hef + 1,25 (≥4)	42.5	1.67	20	15
1/2	15	9/16	70	2 3/4	254	10	hef + 2d ₀	hef + 2d ₀	57.5	2.26	41	30
5/8	18	3/4	79	3 1/8	318	12 1/2			65	2.56	68	50
3/4	22	7/8	89	3 1/2	381	15			80	3.15	122	90
7/8	25	1	89	3 1/2	445	17 1/2			95	3.74	136	100
1	28	1 1/8	102	4	508	20			110	4.33	183	135
1 1/8	32	1 1/4	114	4 1/2	572	22 1/2			135	5.31	244	180
1 1/4	35	1 3/8	127	5	635	25			160	6.30	325	240

Table VII. Fractional reinforcing bars

d _a / d _b [-]	d ₀ [mm]	d ₀ [inch]	h _{ef,min} [mm]	h _{ef,min} [inch]	h _{ef,max} [mm]	h _{ef,max} [inch]	h _{min} [mm]	h _{min} [inch]	S _{min} = C _{min} [mm]	S _{min} = C _{min} [inch]	max T _{inst} ¹ [Nm]	max T _{inst} ¹ [ft · lb]
#3	14	1/2	60	2 3/8	191	7 1/2	hef + 30 (≥100)	hef + 1,25 (≥4)	43	1.69	30	22
#4	16	5/8	70	2 3/4	254	10	hef + 2d ₀	hef + 2d ₀	58	2.28	60	44
#5	20	13/16	79	3 1/8	318	12 1/2			65	2.56	110	81
#6	22	7/8	89	3 1/2	381	15			80	3.15	175	129
#7	28	1 1/8	89	3 1/2	445	17 1/2			95	3.74	240	177
#8	32	1 1/4	102	4	508	20			110	4.33	320	236
#9	35	1 3/8	114	4 1/2	572	22 1/2			130	5.12	380	280
#10	40	1 1/2	127	5	635	25			160	6.30	450	332
#11	45	1 3/4	140	5 1/2	699	27 1/2			175	6.89	450	332

¹Torque moment only required when using threaded reinforcing bars to resist seismic loading

Table VIII. Fractional internal threaded anchor

d _e [inch]	d _a [mm]	d _a [inch]	d ₀ [mm]	d ₀ [inch]	h _{ef} [mm]	h _{ef} [inch]	h _{min} [mm]	h _{min} [inch]	S _{min} = C _{min} [mm]	S _{min} = C _{min} [inch]	max T _{inst} [Nm]	max T _{inst} [ft · lb]
RG MI 3/8	16	5/8	18	3/4	90	3,54	125	4,92	65	2,56	20	15
RG MI 1/2	18	11/16	20	13/16	125	4,92	165	6,50	75	2,95	40	30
RG MI 5/8	22	7/8	24	1	160	6,30	205	8,07	95	3,74	80	59
RG MI 3/4	28	1 1/8	32	1 1/4	200	7,87	260	10,24	125	4,92	120	89

FIGURE 6—FIS EM PLUS INSTALLATION INFORMATION (Continued)

Table IX. Processing and curing times

Temperature Range ¹		Working time / processing time	Curing time
[°C]	[°F]	t _{work} [min]	t _{cure} [h]
-5 to 0	23 to 32	240	200
> 0 to 5	> 32 to 41	150	90
> 5 to 10	> 41 to 50	120	40
> 10 to 20	> 50 to 68	30	22
> 20 to 30	> 68 to 86	14	10
> 30 to 40	> 86 to 104	7	5

¹Minimal cartridge temperature +5 °C / +41 °F

FIGURE 6—FIS EM PLUS INSTALLATION INFORMATION (Continued)

Thread end geometry threaded rod
fischer FIS A

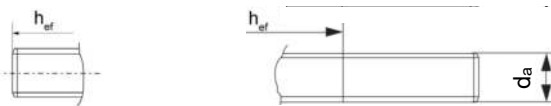

Alternative head geometry
fischer FIS A and RG M

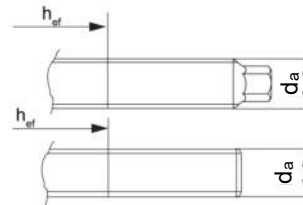

Alternative point geometry threaded rod
fischer FIS A and RG M

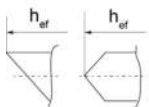

Marking (on random place) fischer anchor rod:

Steel zinc plated PC ¹ 8.8	• or +	Steel hot-dip PC ¹ 8.8	•
High corrosion resistant steel HCR PC ¹ 50	•	High corrosion resistant steel HCR PC ¹ 70	-
High corrosion resistant steel HCR PC ¹ 80	(Stainless steel R property class 50	~
Stainless steel R property class 80	* ¹		

Alternatively: Colour coding according to DIN 976-1:2016

¹PC = property class

FIGURE 7—FISCHER THREADED RODS FIS A AND RGM



Cartridge System FIS EM Plus 390 S, 585 S and 1500 S



Threaded Rod



Reinforcing Bar



Internal Threaded Anchor
fischer RG M I



Static Mixer e.g. fischer FIS MR Plus



Injection Adapters



Extension Tube



Dispenser e.g. fischer FIS DM S



Dust extraction system e.g. fischer FVC 35 M



Hollow Drill Bit e.g. fischer FHD

FIGURE 8—FIS EM PLUS ANCHORING SYSTEM, STEEL ELEMENTS AND ACCESSORIES

DIVISION: 03 00 00—CONCRETE**Section: 03 16 00—Concrete Anchors****DIVISION: 05 00 00—METALS****Section: 05 05 19—Post-Installed Concrete Anchors****REPORT HOLDER:**

fischerwerke GmbH & Co. KG

EVALUATION SUBJECT:**fischer FIS EM PLUS ADHESIVE ANCHORING SYSTEM AND POST INSTALLED REINFORCING BAR CONNECTIONS FOR CRACKED AND UNCRACKED CONCRETE**

1.0 REPORT PURPOSE AND SCOPE

Purpose:

The purpose of this evaluation report supplement is to indicate that the fischer FIS EM Plus Adhesive Anchoring System and Post-Installed Reinforcing Bar System in cracked and uncracked concrete, described in ICC-ES evaluation report [ESR-1990](#), have also been evaluated for compliance with the codes noted below as adopted by the Los Angeles Department of Building and Safety (LADBS).

Applicable code editions:

- 2020 *City of Los Angeles Building Code* (LABC)
- 2020 *City of Los Angeles Residential Code* (LARC)

2.0 CONCLUSIONS

The the fischer FIS EM Plus Adhesive Anchoring System and Post-Installed Reinforcing Bar System in cracked and uncracked concrete, described in Sections 2.0 through 7.0 of the evaluation report [ESR-1990](#), comply with the LABC Chapter 19, and the LARC, and are subject to the conditions of use described in this supplement.

3.0 CONDITIONS OF USE

The the fischer FIS EM Plus Adhesive Anchoring System and Post-Installed Reinforcing Bar System in cracked and uncracked concrete described in this evaluation report must comply with all of the following conditions:

- All applicable sections in the evaluation report [ESR-1990](#).
- The design, installation, conditions of use and labeling of the anchors are in accordance with the 2018 *International Building Code*® (IBC) provisions noted in the evaluation report [ESR-1990](#).
- The design, installation and inspection are in accordance with additional requirements of LABC Chapters 16 and, 17, as applicable.
- Under the LARC, an engineered design in accordance with LARC Section R301.1.3 must be submitted.
- The allowable and strength design values listed in the evaluation report and tables are for the connection of the adhesive anchors or post-installed reinforcing bars to the concrete. The connection between the adhesive anchors or post-installed reinforcing bars and the connected members shall be checked for capacity (which may govern).
- For use in wall anchorage assemblies to flexible diaphragm applications, anchors shall be designed per the requirements of City of Los Angeles Information Bulletin P/BC 2020-071.

This supplement expires concurrently with the evaluation report, reissued September 2021.

DIVISION: 03 00 00— CONCRETE
Section: 03 16 00— Concrete Anchors

DIVISION: 05 00 00—METALS
Section: 05 05 19—Post-Installed Concrete Anchors

REPORT HOLDER:

fischerwerke GmbH & Co. KG

EVALUATION SUBJECT:

fischer FIS EM PLUS ADHESIVE ANCHORING SYSTEM AND POST INSTALLED REINFORCING BAR CONNECTIONS FOR CRACKED AND UNCRACKED CONCRETE

1.0 REPORT PURPOSE AND SCOPE**Purpose:**

The purpose of this evaluation report supplement is to indicate that the fischer FIS EM Plus Adhesive Anchoring System and Post Installed Reinforcing Bar Connections in cracked and uncracked concrete, described in ICC-ES evaluation report ESR-1990, have also been evaluated for compliance with the code(s) noted below.

Applicable code edition(s):

- 2019 *California Building Code* (CBC)

For evaluation of applicable chapters adopted by the California Office of Statewide Health Planning and Development (OSHPD) and Division of State Architect (DSA), see Sections 2.1.1 and 2.1.2 below.

- 2019 *California Residential Code* (CRC)

2.0 CONCLUSIONS**2.1 CBC:**

The fischer FIS EM Plus Adhesive Anchoring System and Post Installed Reinforcing Bar Connections in cracked and uncracked concrete, described in Sections 2.0 through 7.0 of the evaluation report ESR-1990, comply with CBC Chapter 19, provided the design and installation are in accordance with the 2018 *International Building Code*® (IBC) provisions noted in the evaluation report and the additional requirements of CBC Chapters 16, 17 and 19, as applicable.

2.1.1 OSHPD:

The applicable OSHPD Sections and Chapters of the CBC are beyond the scope of this supplement.

2.1.2 DSA:

The applicable DSA Sections and Chapters of the CBC are beyond the scope of this supplement.

2.2 CRC:

The fischer FIS EM Plus Adhesive Anchoring System and Post Installed Reinforcing Bar Connections in cracked and uncracked concrete, described in Sections 2.0 through 7.0 of the evaluation report ESR-1990, comply with CRC Section R301.1.3, provided the design and installation are in accordance with the 2018 *International Building Code*® (IBC) provisions noted in the evaluation report and the additional requirements of CBC Chapters 16, 17 and 19, as applicable.

This supplement expires concurrently with the evaluation report, reissued September 2021.

DIVISION: 03 00 00—CONCRETE

Section: 03 16 00—Concrete Anchors

DIVISION: 05 00 00—METALS

Section: 05 05 19—Post-Installed Concrete Anchors

REPORT HOLDER:

fischerwerke GmbH & Co. KG

EVALUATION SUBJECT:**fischer FIS EM PLUS ADHESIVE ANCHORING SYSTEM AND POST INSTALLED REINFORCING BAR CONNECTIONS FOR CRACKED AND UNCRACKED CONCRETE****1.0 REPORT PURPOSE AND SCOPE****Purpose:**

The purpose of this evaluation report supplement is to indicate that the fischer FIS EM Plus Adhesive Anchoring System and Post-Installed Reinforcing Bar System, described in ICC-ES evaluation report ESR-1990, has also been evaluated for compliance with the codes noted below.

Applicable code editions:

- 2020 *Florida Building Code—Building*
- 2020 *Florida Building Code—Residential*

2.0 CONCLUSIONS

The fischer FIS EM Adhesive Anchoring System and Post-Installed Reinforcing Bar System, described in Sections 2.0 through 7.0 of the evaluation report ESR-1990, comply with the *Florida Building Code—Building* and the *Florida Building Code—Residential*, provided the design requirements are determined in accordance with the *Florida Building Code—Building* or the *Florida Building Code—Residential*, as applicable. The installation requirements noted in ICC-ES evaluation report ESR-1990 for the 2018 *International Building Code*® meet the requirements of the *Florida Building Code—Building* or the *Florida Building Code—Residential*, as applicable.

Use of the fischer FIS EM Plus Adhesive Anchoring System and Post-Installed Reinforcing Bar System has also been found to be in compliance with the High-Velocity Hurricane Zone provisions of the *Florida Building Code—Building* and the *Florida Building Code—Residential* with the following condition:

- a) For connections subject to uplift, the connection must be designed for no less than 700 pounds (3114 N).

For products falling under Florida Rule 61G20-3, verification that the report holder's quality-assurance program is audited by a quality-assurance entity approved by the Florida Building Commission for the type of inspections being conducted is the responsibility of an approved validation entity (or the code official, when the report holder does not possess an approval by the Commission).

This supplement expires concurrently with the evaluation report, reissued September 2021.