



LEISTUNGSERKLÄRUNG



DoP: 00121

für fischer Bolzenanker FAZ II (Kraftkontrolliert spreizender Dübel) – DE

1. Eindeutiger Kenncode des Produkttyps: DoP: 00121

2. Verwendungszweck(e):

Nachträgliche Befestigung im gerissenen und ungerissenen Beton, siehe Anhang, insbesondere Anhänge B 1 bis B 6

3. Hersteller: **fischerwerke GmbH & Co. KG, Klaus-Fischer-Straße 1, 72178 Waldachtal, Deutschland**

4. Bevollmächtigter: --

5. System(e) zur Bewertung und Überprüfung der Leistungsbeständigkeit: 1

6. Europäisches Bewertungsdokument: **EAD 330232-00-0601**

Europäische Technische Bewertung: **ETA-05/0069; 2017-07-03**

Technische Bewertungsstelle: **DIBt**

Notifizierte Stelle(n): **1343 – MPA Darmstadt**

7. Erklärte Leistung(en):

Mechanische Festigkeit und Standsicherheit (BWR 1),

- **Charakteristischer Widerstand für statische und quasi-statische Einwirkungen: Siehe Anhang, insbesondere Anhänge C 1 bis C 2**
- **Charakteristische Werte für die seismische Leistungskategorien C 1 und C 2: Siehe Anhang, insbesondere Anhang C 4**
- **Verschiebungen: Siehe Anhang, insbesondere Anhang C 5**

Brandschutz (BWR 2)

- **Brandverhalten: Der Dübel erfüllt die Anforderungen der Klasse A 1**
- **Charakteristischer Widerstand unter Brandbeanspruchung: Siehe Anhang, insbesondere Anhang C 3**

8. Angemessene Technische Dokumentation und/oder Spezifische Technische Dokumentation: ---

Die Leistung des vorstehenden Produkts entspricht der erklärten Leistung/den erklärten Leistungen. Für die Erstellung der Leistungserklärung im Einklang mit der Verordnung (EU) Nr. 305/2011 ist allein der obengenannte Hersteller verantwortlich.

Unterzeichnet für den Hersteller und im Namen des Herstellers von:

Andreas Bucher, Dipl.-Ing.

Wolfgang Hengesbach, Dipl.-Ing., Dipl.-Wirtsch.-Ing.

i.V. A. Bucher

i.V. W. Hengesbach

Tumlingen, 2017-07-10

- Diese Leistungserklärung wurde in verschiedenen Sprachversionen erstellt. Für den Fall unterschiedlicher Auslegung hat immer die englische Version Vorrang.
- Der Anhang enthält freiwillige und ergänzende Informationen in englischer Sprache. Diese gehen über die (sprachneutral angegebenen) gesetzlichen Anforderungen hinaus.

Specific Part

1 Technical description of the product

The Fischer Bolt Anchor FAZ II is an anchor made of galvanised steel (FAZ II) or made of stainless steel (FAZ II A4) or high corrosion resistant steel (FAZ II C) which is placed into a drilled hole and anchored by torque-controlled expansion.

The product description is given in Annex A.

2 Specification of the intended use in accordance with the applicable European Assessment Document

The performances given in Section 3 are only valid if the anchor is used in compliance with the specifications and conditions given in Annex B.

The verifications and assessment methods on which this European Technical Assessment is based lead to the assumption of a working life of the anchor of at least 50 years. The indications given on the working life cannot be interpreted as a guarantee given by the producer, but are to be regarded only as a means for choosing the right products in relation to the expected economically reasonable working life of the works.

3 Performance of the product and references to the methods used for its assessment

3.1 Mechanical resistance and stability (BWR 1)

Essential characteristic	Performance
Characteristic resistance for static and quasi static action	See Annex C 1 and C 2
Characteristic resistance for seismic performance categories C1 and C2	See Annex C 4
Displacements	See Annex C 5

3.2 Safety in case of fire (BWR 2)

Essential characteristic	Performance
Reaction to fire	Anchorage satisfy requirements for Class A1
Characteristic resistance under fire exposure	See Annex C 3

4 Assessment and verification of constancy of performance (AVCP) system applied, with reference to its legal base

In accordance with EAD 330232-00-0601, the applicable European legal act is: [96/582/EC].

The system to be applied is: 1

Cone bolt manufactured by cold - forming:

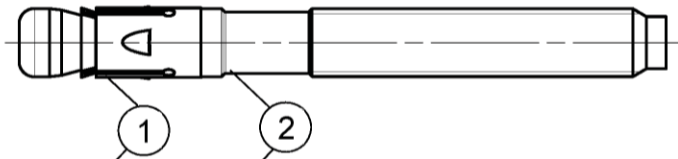

Cone bolt manufactured by turning:

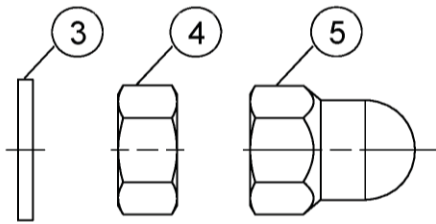

- ① Expansion sleeve
- ② Cone bolt (cold – formed or turned)
- ③ Washer
- ④ Hexagon nut
- ⑤ fischer FAZ II dome nut

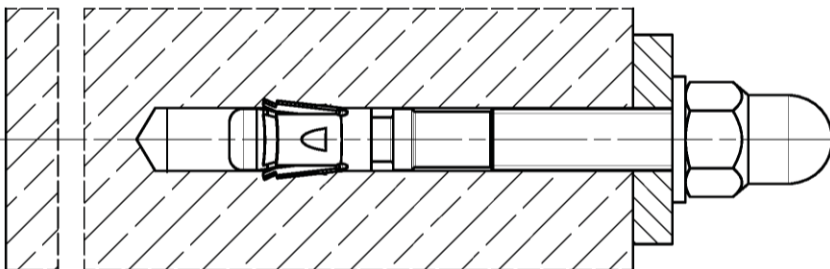
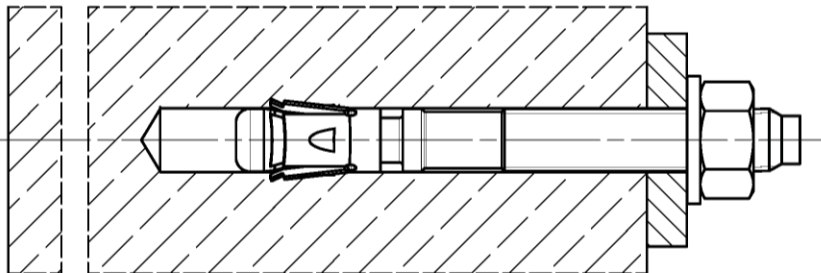

(Fig. not to scaled)

fischer Bolt Anchor FAZ II, FAZ II A4, FAZ II C

Product description
Installed condition

Annex A 1

Product label and letter-code:

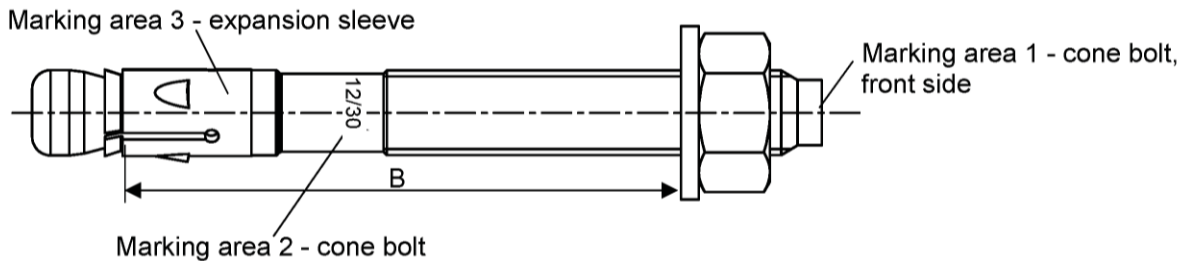

Product label, example:



Brand | type of fastener placed at marking area 2 or marking area 3

Thread size / max. thickness of the fixture (t_{fix}) identification A4 or C placed at marking area 2

- FAZ II: carbon steel, galvanized
- FAZ II A4: stainless steel
- FAZ II C: high corrosion resistant steel

Table A2.1: Letter - code at marking area 1:

Marking	(a)	(b)	(c)	(d)	(A)	(B)	(C)	(D)	(E)	(F)	(G)	(H)	(I)	(K)	
Max. t_{fix}	5	10	15	20	5	10	15	20	25	30	35	40	45	50	
B ≥ [mm]	M6	-			45	50	55	60	65	70	75	80	85	90	
	M8	40	45	-		50	55	60	65	70	75	80	85	90	95
	M10	45	50	55	60	65	70	75	80	85	90	95	100	105	110
	M12	55	60	65	70	75	80	85	90	95	100	105	110	115	120
	M16	70	75	80	85	90	95	100	105	110	115	120	125	130	135
	M20	-				105	110	115	120	125	130	135	140	145	150
	M24	-				130	135	140	145	150	155	160	165	170	175
Marking	(L)	(M)	(N)	(O)	(P)	(R)	(S)	(T)	(U)	(V)	(W)	(X)	(Y)	(Z)	
Max. t_{fix}	60	70	80	90	100	120	140	160	180	200	250	300	350	400	
B ≥ [mm]	M6	100	110	120	130	140	160	180	200	220	240	290	340	390	440
	M8	105	115	125	135	145	165	185	205	225	245	295	345	395	445
	M10	120	130	140	150	160	180	200	220	240	260	310	360	410	460
	M12	130	140	150	160	170	190	210	230	250	270	320	370	420	470
	M16	145	155	165	175	185	205	225	245	265	285	335	385	435	485
	M20	160	170	180	190	200	220	240	260	280	300	350	400	450	500
	M24	185	195	205	215	225	245	265	285	305	325	375	425	475	525

Calculation existing h_{ef} for installed fasteners:

$$\text{existing } h_{ef} = B_{(\text{according to table A2.1})} - \text{existing } t_{fix}$$

Thickness of the fixture t_{fix} including thickness of fastener plate t and e.g. thickness of grout layer t_{grout} or other non-structural layers

(Fig. not to scaled)

fischer Bolt Anchor FAZ II, FAZ II A4, FAZ II C

Product description
Product label and letter code

Annex A 2

Product dimensions

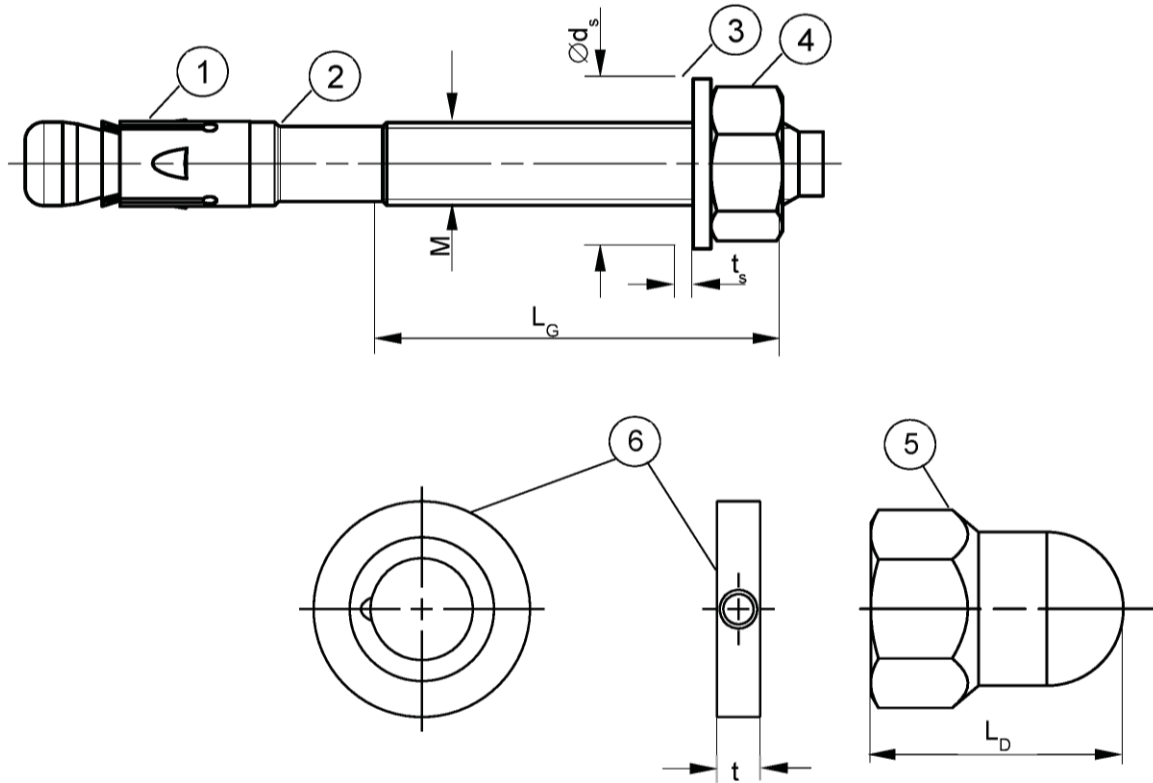

Table A3.1: Dimensions [mm]

Part	Designation		FAZ II, FAZ II A4, FAZ II C						
			M6	M8	M10	M12	M16	M20	M24
1	Expansion sleeve	Sheet thickness	0,8	1,3	1,4	1,6	2,4		3,0
2	Cone bolt	Thread size M	6	8	10	12	16	20	24
		L_G	10	19	26	31	40	50	57
3	Washer	t_s	1,4		1,8	2,3	2,7		3,7
		$\varnothing d_s$	11	15	19	23	29	36	43
4 & 5	Hexagon nut / fischer FAZ II dome nut	Wrench size	10	13	17	19	24	30	36
5		L_D	-		22	27	33	-	
6	fischer filling disc FFD	t	6			7	8	10	

(Fig. not to scaled)

fischer Bolt Anchor FAZ II, FAZ II A4, FAZ II C

Product description
Dimensions

Annex A 3

Specifications of intended use							
Anchorages subject to:							
Size	FAZ II, FAZ II A4, FAZ II C						
	M6	M8	M10	M12	M16	M20	M24
Static and quasi-static loads							
Cracked and uncracked concrete				✓			
Fire exposure							
Seismic performance category	C1	-			✓		
	C2 ¹⁾	-			✓		-
¹⁾ FAZ II C: Only valid for cold-formed version (according to Annex A1)							
Base materials: <ul style="list-style-type: none"> Reinforced and unreinforced normal weight concrete (cracked and uncracked) according to EN 206-1: 2000 Strength classes C20/25 to C50/60 according to EN 206-1: 2000 							
Use conditions (Environmental conditions): <ul style="list-style-type: none"> Structures subject to dry internal conditions (FAZ II, FAZ II A4, FAZ II C) Structures subject to external atmospheric exposure (including industrial and marine environment) and to permanently damp internal condition, if no particular aggressive conditions exist (FAZ II A4, FAZ II C) Structures subject to external atmospheric exposure and permanently damp internal condition, if other particular aggressive conditions exist (FAZ II C) 							
Note: Particular aggressive conditions are e.g. permanent, alternating immersion in seawater or the splash zone of seawater, chloride atmosphere of indoor swimming pools or atmosphere with extreme chemical pollution (e.g. in desulphurization plants or road tunnels where deicing materials are used)							
Design: <ul style="list-style-type: none"> Anchorages are to be designed under the responsibility of an engineer experienced in anchorages and concrete work Verifiable calculation notes and drawings are to be prepared taking account of the loads to be anchored. The position of the anchor is indicated on the design drawings (e.g. position of the anchor relative to reinforcement or to supports, etc.) Design of fastenings according to FprEN 1992-4: 2016 and EOTA Technical Report TR 055 For effective embedment depth $h_{ef} < 40$ mm and $h_{min} \geq 80$ mm and < 100 mm only statically indeterminate fixings (e.g. light-weight suspended ceilings with internal exposure) are covered by the ETA 							
fischer Bolt Anchor FAZ II, FAZ II A4, FAZ II C							Annex B 1
Intended Use Specifications							

Table B2.1: Installation parameters

Size	FAZ II, FAZ II A4, FAZ II C						
	M6	M8	M10	M12	M16	M20	M24
Nominal drill hole diameter $d_0 =$	6	8	10	12	16	20	24
Maximum bit diameter with hammer or hollow drilling $d_{cut,max}$ [mm]	6,40	8,45	10,45	12,5	16,5	20,55	24,55
Maximum bit diameter with diamond drilling	-	8,15		12,25	16,45	20,50	24,40
Overall fastener embedment depth in the concrete $h_{nom} \geq (L)$ [mm]	46,5 (6,5)	44,5 (9,5)	52,0 (12)	63,5 (13,5)	82,5 (17,5)	120 (20)	148,5 (23,5)
Depth of drill hole to deepest point $h_1 \geq$	Existing $h_{ef} + L = h_{nom}$						
Diameter of clearance hole in the fixture $d_f \leq$ [mm]	$h_{nom} + 5$					$h_{nom} + 10$	
Required setting torque $T_{inst} =$ [Nm]	7	9	12	14	18	22	26
Excess length after hammering-in the cone bolt (for fischer dome nut applications according to Annex B6) $O =$ [mm]	8	20	45	60	110	200	270
	-		12	16	20	-	-

Setting gauge FAZ II SL-H
for anchor with fischer FAZ II dome nut:

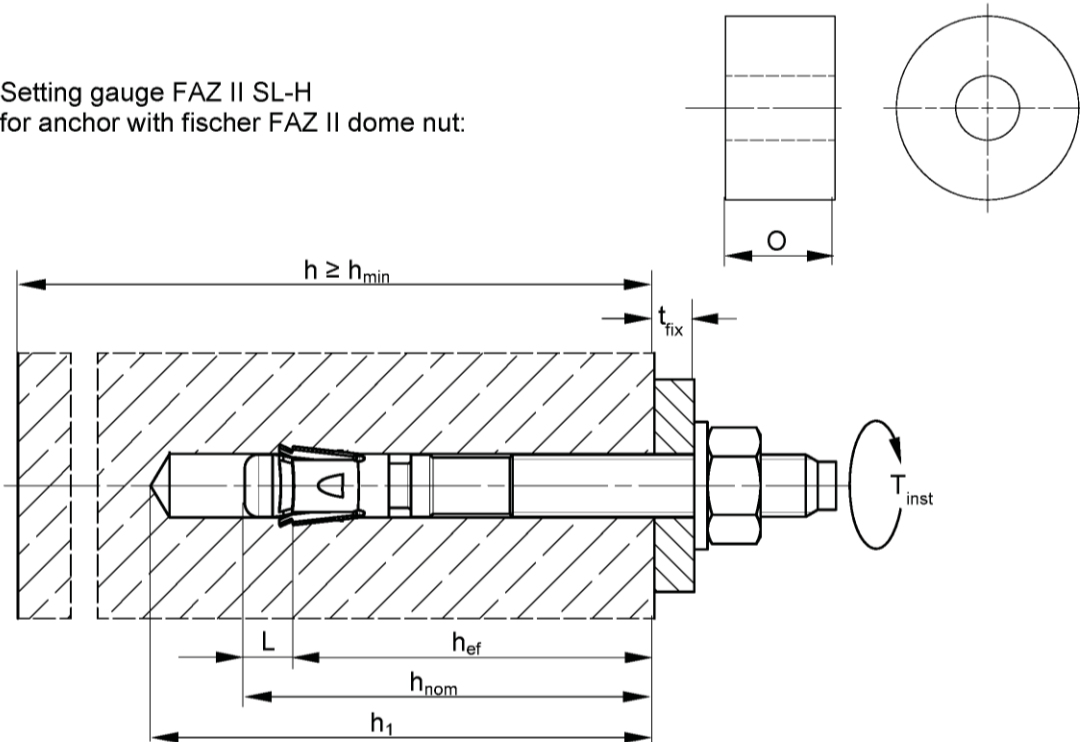

- h_{ef} = Effective embedment depth
- t_{fix} = Thickness of the fixture
- h_1 = Depth of drill hole to deepest point
- h = Thickness of the concrete member
- h_{min} = Minimum thickness of concrete member
- h_{nom} = Overall fastener embedment depth in the concrete
- T_{inst} = Required setting torque

(Fig. not to scaled)

fischer Bolt Anchor FAZ II, FAZ II A4, FAZ II C

Intended Use
Installation parameters

Annex B 2

Table B3.1: Minimum thickness of concrete members, minimum spacing and minimum edge distance

Size	FAZ II, FAZ II A4, FAZ II C						
	M6	M8	M10	M12	M16	M20	M24
Minimum edge distance							
Uncracked concrete	45	40	45	55	65	95	135
Cracked concrete						85	100
Minimum spacing	according to Annex B4						
Minimum thickness of concrete member	80			100	140	160	200
Thickness of concrete member	max. { $h_{min}; h_1^{1)}$ + 30}				max. { $h_{min}; h_1^{1)}$ + 2 · d_o }		
Minimum spacing							
Uncracked concrete	35	40	40	50	65	95	100
Cracked concrete		35					
Minimum edge distance	according to Annex B4						
Minimum thickness of concrete member	80			100	140	160	200
Thickness of concrete member	max. { $h_{min}; h_1^{1)}$ + 30}				max. { $h_{min}; h_1^{1)}$ + 2 · d_o }		
Minimal splitting area							
Uncracked concrete	5,1	18	37	54	67	100	117,5
Cracked concrete							

¹⁾ h_1 according to Annex B2

Splitting failure applied for minimum edge distance and spacing in dependence of the h_{ef}

For the calculation of minimum spacing and minimum edge distance of anchors in combination with different embedment depths and thicknesses of concrete members the following equation shall be fulfilled:

$$A_{sp,req} < A_{sp,ef}$$

$A_{sp,req}$ = required splitting area

$A_{sp,ef}$ = effective splitting area (according to Annex B4)

fischer Bolt Anchor FAZ II, FAZ II A4, FAZ II C

Annex B 3

Intended Use

Minimum thickness of member, minimum spacing and edge distance

Table B4.1: Effective splitting area $A_{sp,ef}$ with member thickness $h > h_{ef} + 1,5 \cdot c$ and $h \geq h_{min}$

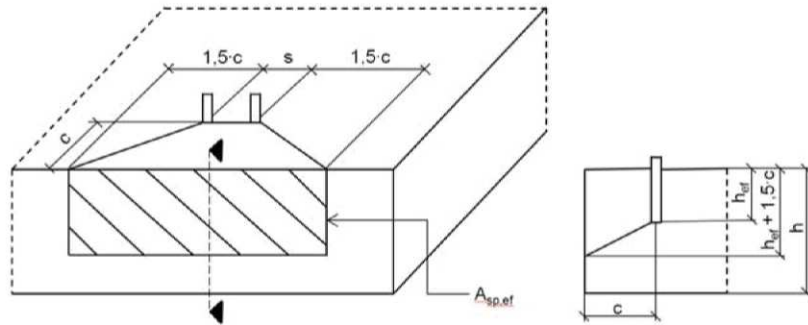

Single anchor and group of anchors with $s > 3 \cdot c$	$A_{sp,ef} = (6 \cdot c) \cdot (h_{ef} + 1,5 \cdot c)$	[mm ²]	with $c \geq c_{min}$
Group of anchors with $s \leq 3 \cdot c$	$A_{sp,ef} = (3 \cdot c + s) \cdot (h_{ef} + 1,5 \cdot c)$	[mm ²]	with $c \geq c_{min}$ and $s \geq s_{min}$

Table B4.2: Effective splitting area $A_{sp,ef}$ with member thickness $h \leq h_{ef} + 1,5 \cdot c$ and $h \geq h_{min}$

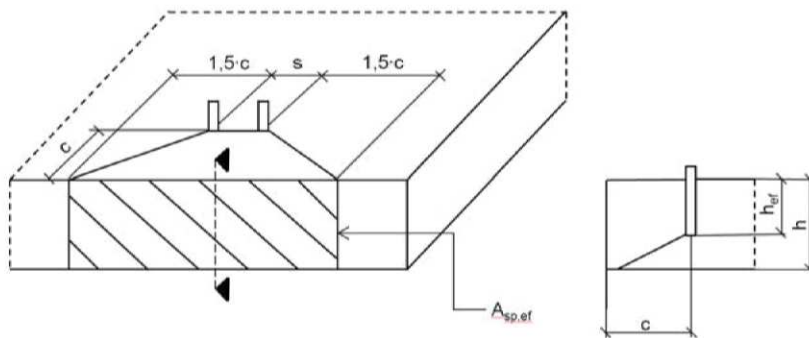

Single anchor and group of anchors with $s > 3 \cdot c$	$A_{sp,ef} = 6 \cdot c \cdot \text{existing } h$	[mm ²]	with $c \geq c_{min}$
Group of anchors with $s \leq 3 \cdot c$	$A_{sp,ef} = (3 \cdot c + s) \cdot \text{existing } h$	[mm ²]	with $c \geq c_{min}$ and $s \geq s_{min}$

Edge distance and axial spacing shall be rounded to at least 5 mm

(Fig. not to scaled)

fischer Bolt Anchor FAZ II, FAZ II A4, FAZ II C

Annex B 4

Intended Use





Minimum thickness of member, minimum spacings and edge distances

Installation instructions:

- Anchor installation carried out by appropriately qualified personnel and under the supervision of the person responsible for technical matters of the site
- Use of the anchor only as supplied by the manufacturer without exchanging the components of the anchor
Exception: fischer FAZ II dome nut.
- Checking before placing the anchor to ensure that the strength class of the concrete in which the anchor is to be placed is in the range given and is not lower than that of the concrete to which the characteristic loads apply
- Check of concrete being well compacted, e.g. without significant voids
- Hammer, hollow or diamond drilling according to Annex B5
- Drill hole created perpendicular +/- 5° to concrete surface, positioning without damaging the reinforcement
- In case of aborted hole: new drilling at a minimum distance twice the depth of the aborted drill hole or smaller distance if the aborted drill hole is filled with high strength mortar and if under shear or oblique tension load it is not in the direction of load application
- It must be ensured that in case of fire local spalling of the concrete cover does not occur
- Fastenings in stand-off installation or with a grout layer under seismic action are not covered
- In case of seismic applications the fastener shall be positioned outside of critical regions (e.g. plastic hinges) of the concrete structure

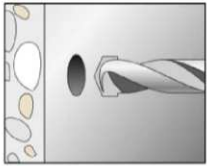
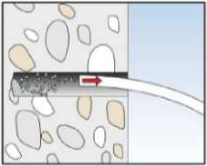
Installation instructions: Drilling and cleaning the hole

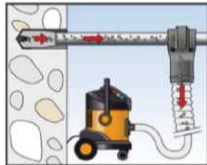
Types of drills and cleaning

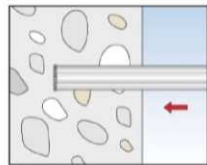
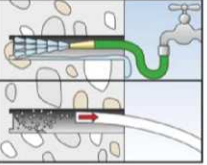
<p>Hammer drill</p>		 <p>1: Drill the hole</p>	 <p>2: Clean the hole</p>
<p>Hollow drill</p>		 <p>1: Drill the hole with automatic cleaning</p>	<p>-</p>
<p>Diamond drill, for non seismic applications only and ≥ drill Ø 8</p>		 <p>1: Drill the hole</p>	 <p>2: Clean the hole</p>

fischer Bolt Anchor FAZ II, FAZ II A4, FAZ II C

Intended Use
Installation instructions

Annex B 5

Installation instructions: Installation of the anchor

HEXAGON NUT:

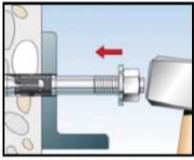

3: Set the fastener

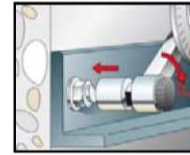

4: Apply T_{inst}

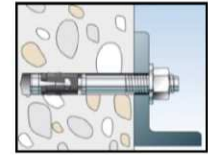

5: Installed fastener

fischer FAZ II DOME NUT:

Option 1: Push through installation with setting gauge SL-H:

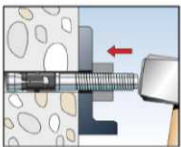

3: Set the fastener using setting gauge

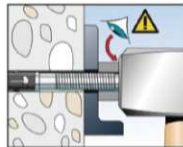

4: Check offset

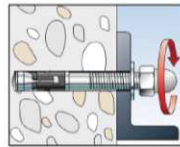

5: Turn on the washer and fischer FAZ II dome nut

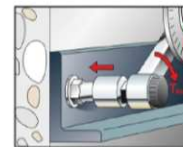

6: Apply T_{inst}

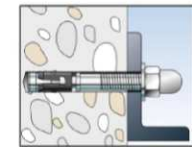

7: Installed fastener

Option 2: Push through installation with hexagon nut:

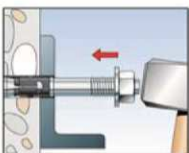

3: Set the fastener

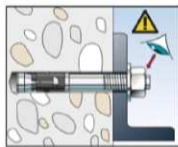

4: check setting position: Visible one turn of a thread

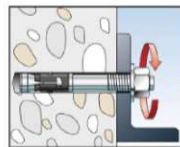

4.1: Remove nut

fischer FILLING DISC FFD optional for seismic C2 application or minimizing the annular gap:

Optional	<p>The gap between bolt and fixture may be filled with mortar (compressive strength $\geq 50 \text{ N/mm}^2$ e.g. FIS SB) after step 7 (for eliminating the annular gap). The filling disc is additional to the standard washer. The thickness of the filling disc must be considered for definition of t_{fix}. Countersunk of the filling disc in direction to the anchor plate.</p>	
----------	---	--

fischer Bolt Anchor FAZ II, FAZ II A4, FAZ II C	Annex B 6
Intended Use Installation instructions	

Table C1.1: Characteristic tension resistance under static and quasi-static action													
Size	FAZ II, FAZ II A4, FAZ II C												
	M6	M8	M10	M12	M16	M20	M24						
Steel failure													
Characteristic resistance	FAZ II	$N_{Rk,s}$ [kN]	7,6	16,6	28,3	43,2	67,0	123,3	176,7				
	FAZ II A4/C										11,4	17,0	29,0
Partial factor for steel failure		$\gamma_{Ms}^{1)}$ [-]	1,5										
Pullout failure													
Effective embedment depth for calculation		h_{ef} [mm]	40	35 - < 45	45	40 - 60	50 - 70	65 - 85	100	125			
Characteristic resistance in cracked concrete C20/25		$N_{Rk,p}$ [kN]	1,5	5,5	8	13	20	- ²⁾					
Characteristic resistance in uncracked concrete C20/25			10,5	14		20	22						
Increasing factors for $N_{Rk,p}$ for cracked and uncracked concrete		ψ_c	C25/30				1,12						
			C30/37				1,22						
			C35/45				1,32						
			C40/50				1,41						
			C45/55				1,50						
			C50/60				1,58						
Installation sensitivity factor		γ_{inst} [-]					1,0						
Concrete cone and splitting failure													
Factor for uncracked concrete		$k_1 = k_{ucr,N}$ [-]					11,0 ³⁾						
Factor for cracked concrete		$k_1 = k_{cr,N}$ [-]					7,7 ³⁾						
Characteristic spacing		$s_{cr,N}$ [mm]					$3 \cdot h_{ef}$						
Characteristic edge distance		$c_{cr,N}$ [mm]					$1,5 \cdot h_{ef}$						
Spacing		$s_{cr,sp}$	$2 \cdot c_{cr,sp}$										
Edge distance for h = 80		$c_{cr,sp}$ [mm]	40	$2 \cdot h_{ef}$	$1,9 \cdot h_{ef}$	$1,5 \cdot h_{ef}$	$2 \cdot h_{ef}$	-		$2,4 \cdot h_{ef}$	$2,2 \cdot h_{ef}$		
Edge distance for h = 100												$2,4 \cdot h_{ef}$	$2 \cdot h_{ef}$
Edge distance for h = 120												$2 \cdot h_{ef}$	$2,1 \cdot h_{ef}$
Edge distance for h = 140													
Edge distance for h = 160													
Edge distance for h = 200													
¹⁾ In absence of other national regulations ²⁾ Pullout failure not relevant ³⁾ Based on concrete strength as cylinder strength													
fischer Bolt Anchor FAZ II, FAZ II A4, FAZ II C									Annex C 1				
Performances Characteristic values of resistance under tension loads													

Table C2.1: Characteristic values of shear resistance under static and quasi-static action									
Size	FAZ II, FAZ II A4, FAZ II C								
	M6	M8	M10	M12	M16	M20	M24		
Steel failure without lever arm									
Characteristic resistance	$\frac{\text{FAZ II}}{\text{FAZ II A4/C}}$	$V_{Rk,s}$ [kN]	5,9	13,6	21,4	30,6	55,0	81,4	110,1
Partial factor for steel failure		$\gamma_{Ms}^{1)}$ [-]	1,25						
Factor for ductility		k_7	1,0						
Steel failure with lever arm and Concrete pryout failure									
Effective embedment depth for calculation		h_{ef} [mm]	40	45	60	70	85	100	125
Characteristic bending resistance	$\frac{\text{FAZ II}}{\text{FAZ II A4/C}}$	$M_{Rk,s}^0$ [Nm]	11,4	26	52	92	233	513	865
Factor for pryout failure		k_8 [-]	2,6	2,8	3,2		3,0	2,6	2,4
Effective embedment depth for calculation		h_{ef} [mm]		35 - < 45	40 - < 60	50 - < 70	65 - < 85		
Characteristic bending resistance	$\frac{\text{FAZ II}}{\text{FAZ II A4/C}}$	$M_{Rk,s}^0$ [Nm]	-	20	44	92	184		-
Factor for pryout failure		k_8 [-]		21	45	100	193		
Partial factor for steel failure		$\gamma_{Ms}^{1)}$ [-]	1,25						
Factor for ductility		k_7	1,0						
Concrete edge failure									
Effective embedment depth for calculation		$l_f =$ [mm]	h_{ef}						
Outside diameter of a fastener		d_{nom}	6	8	10	12	16	20	24
¹⁾ In absence of other national regulations									
fischer Bolt Anchor FAZ II, FAZ II A4, FAZ II C							Annex C 2		
Performances Characteristic values of resistance under shear loads									

Table C3.1: Characteristic values of tension resistance under fire exposure									
Size		FAZ II, FAZ II A4, FAZ II C							
		M6	M8	M10	M12	M16	M20	M24	
$h_{ef} \geq$ [mm]		40	35 / 45	40 / 60	50 / 70	65 / 85	100	125	
Characteristic resistance steel failure	$N_{Rk,s,fi}$	R30	0,6 ¹⁾ / 0,9 ²⁾	1,4	2,8	5,0	9,4	14,7	21,1
		R60	0,4 ¹⁾ / 0,9 ²⁾	1,2	2,3	4,1	7,7	12,0	17,3
		R90	0,3 ¹⁾ / 0,9 ²⁾	0,9	1,9	3,2	6,0	9,4	13,5
		R120	0,2 ¹⁾ / 0,7 ²⁾	0,8	1,6	2,8	5,2	8,1	11,6
Characteristic resistance Concrete cone failure	$N_{Rk,c,fi}$	R30 - R90	$7,7 \cdot h_{ef}^{1,5} \cdot (20)^{0,5} \cdot h_{ef} / 200 / 1000$						
		R120	$7,7 \cdot h_{ef}^{1,5} \cdot (20)^{0,5} \cdot h_{ef} / 200 / 1000 \cdot 0,8$						
Characteristic resistance pullout failure	$N_{Rk,p,fi}$	R30	0,4	0,9 / 2,0	2,2 / 3,3	3,0 / 5,0	4,5 / 6,8	8,6	12,0
		R60		0,8 / 2,0					
		R90	0,5 / 2,0	1,7 / 2,6	2,4 / 4,0	3,6 / 5,4	6,9	9,6	
		R120	0,3						0,3 / 1,6

Table C3.2: Characteristic values of shear resistance under fire exposure

Size FAZ II, FAZ II A4, FAZ II C		R30		R60	
		$V_{Rk,s,fi,30}$ [kN]	$M^0_{Rk,s,fi,30}$ [Nm]	$V_{Rk,s,fi,60}$ [kN]	$M^0_{Rk,s,fi,60}$ [Nm]
M6	40	0,6 ¹⁾ / 0,9 ²⁾	0,5 ¹⁾ / 0,2 ²⁾	0,4 ¹⁾ / 0,9 ²⁾	0,3 ¹⁾ / 0,1 ²⁾
M8	35	1,8	1,4	1,6	1,2
M10	40	3,6		2,9	3,0
M12	50	6,3	7,8	4,9	6,4
M16	65	11,7	19,9	9,1	16,3
M20	100	18,2	39,0	14,2	31,8
M24	125	26,3	67,3	20,5	55,0

Size FAZ II, FAZ II A4, FAZ II C		R90		R120	
		$V_{Rk,s,fi,90}$ [kN]	$M^0_{Rk,s,fi,90}$ [Nm]	$V_{Rk,s,fi,120}$ [kN]	$M^0_{Rk,s,fi,120}$ [Nm]
M6	40	0,3 ¹⁾ / 0,9 ²⁾	0,2 ¹⁾ / 0,1 ²⁾	0,2 ¹⁾ / 0,7 ²⁾	0,2 ¹⁾ / 0,1 ²⁾
M8	35	1,3	1,0	1,2	0,8
M10	40	2,2	2,4	1,9	2,1
M12	50	3,5	5,0	2,8	4,3
M16	65	6,6	12,6	5,3	11,0
M20	100	10,3	24,6	8,3	21,4
M24	125	14,8	42,6	11,9	37,0

Concrete pryout failure according to EN 1992-4

Table C3.3: Minimum spacings and minimum edge distances of anchors under fire exposure for tension and shear load

Size		FAZ II, FAZ II A4, FAZ II C						
		M6	M8	M10	M12	M16	M20	M24
Spacing	s_{min}	Annex B3						
Edge distance	c_{min} [mm]	$c_{min} = 2 \cdot h_{ef}$ for fire exposure from more than one side $c_{min} \geq 300$ mm						

1) FAZ II gvz

2) FAZ II A4 / C

fischer Bolt Anchor FAZ II, FAZ II A4, FAZ II C

Performances
Characteristic values of resistance under fire exposure

Annex C 3

Table C4.1: Characteristic values of tension and shear resistance under seismic action category C1

Size	FAZ II, FAZ II A4, FAZ II C						
	M6	M8	M10	M12	M16	M20	M24
Length of anchor L_{max} [mm]	-	167	186	221	285	394	477
Effective embedment depth h_{ef} [mm]	-	45	40 - 60	50 - 70	65 - 85	100	125
Steel failure							
Characteristic resistance tension load C1 $N_{Rk,s,C1}$ [kN]	-	16,0	27,0	41,0	66,0	111,0	150,0
Partial factor for steel failure $\gamma_{Ms,C1}^{1)}$ [-]	-	1,5					
Pullout failure							
Characteristic resistance tension load in cracked concrete C1 $N_{Rk,p,C1}$ [kN]	-	4,6	8,0	16,0	28,2	36,0	50,3
Installation sensitivity factor γ_{inst} [-]	-	1,0					
Steel failure without lever arm							
Characteristic resistance shear load C1 $V_{Rk,s,C1}$ [kN]	-	11	17	27	47	56	69
Partial factor for steel failure $\gamma_{Ms,C1}^{1)}$ [-]	-	1,25					

¹⁾ In absence of other national regulations

$N_{Rks,eq} = N_{Rk,C1}$ for all failures

Table C4.2: Characteristic values of tension and shear resistance under seismic action category C2

Size	FAZ II, FAZ II A4, FAZ II C ¹⁾						
	M6	M8	M10	M12	M16	M20	M24
Length of anchor L_{max} [mm]	-		186	221	285	394	-
Steel failure							
Characteristic resistance tension load C2 $N_{Rk,s,C2}$ [kN]	-		27	41	66	111	-
Partial factor for steel failure $\gamma_{Ms,C2}^{2)}$ [-]	-		1,5				
Pullout failure							
Characteristic resistance tension load in cracked concrete C2	h_{ef} [mm]	-	60	70	85	100	-
	$N_{Rk,p,C2}$ [kN]	-	5,1	7,4	21,5	30,7	-
	h_{ef} [mm]	-	40-59	50-69	65-84		-
	$N_{Rk,p,C2}$ [kN]	-	2,7	4,4	16,4		-
Installation sensitivity factor γ_{inst} [-]	-		1,0				
Steel failure without lever arm							
Characteristic resistance shear load C2	h_{ef} [mm]	-	60	70	85	100	-
	$V_{Rk,s,C2}$ [kN]	-	10,0	17,4	27,5	39,9	-
	h_{ef} [mm]	-	40-59	50-69	65-84		-
	$V_{Rk,s,C2}$ [kN]	-	7,0	12,7	22,0		-
Partial factor for steel failure $\gamma_{Ms,C2}^{2)}$ [-]	-		1,25				

¹⁾ FAZ II C: Only valid for cold-formed version (according to Annex A1)

²⁾ In absence of other national regulations

$N_{Rks,eq} = N_{Rk,C1}$ for all failures

fischer Bolt Anchor FAZ II, FAZ II A4, FAZ II C

Performances
Characteristic values of resistance under tension and shear loads under seismic action

Annex C 4

Table C5.1: Displacements under static and quasi static tension loads

Size	FAZ II, FAZ II A4, FAZ II C						
	M6	M8	M10	M12	M16	M20	M24
Displacement – factor for tensile load¹⁾							
δ_{N0} - factor	0,13	0,22	0,12	0,09	0,08	0,07	0,05
	1,00	0,78	0,40	0,19	0,09		0,07
$\delta_{N\infty}$ - factor	[mm/kN]						
	0,16	0,07	0,05	0,06		0,05	0,04
	0,24	0,29	0,21	0,14	0,10	0,06	0,05

Table C5.2: Displacements under static and quasi static shear loads

Size	FAZ II						
	M6	M8	M10	M12	M16	M20	M24
Displacement – factor for shear load²⁾							
δ_{V0} - factor	[mm/kN]						
	0,6	0,35	0,37	0,27	0,10	0,09	0,07
	0,9	0,52	0,55	0,40	0,14	0,15	0,11
$\delta_{V\infty}$ - factor	[mm/kN]						
	FAZ II A4, FAZ II C						
	0,6	0,23	0,19	0,18	0,10	0,11	0,07
	0,9	0,27	0,22	0,16	0,11	0,05	0,09

¹⁾ Calculation of effective displacement:
 $\delta_{N0} = \delta_{N0} - \text{factor} \cdot N_{ED}$
 $\delta_{N\infty} = \delta_{N\infty} - \text{factor} \cdot N_{ED}$
 (N_{ED} : Design value of the applied tension force)

²⁾ Calculation of effective displacement:
 $\delta_{V0} = \delta_{V0} - \text{factor} \cdot V_{ED}$
 $\delta_{V\infty} = \delta_{V\infty} - \text{factor} \cdot V_{ED}$
 (V_{ED} : Design value of the applied shear force)

Table C5.3: Displacements under tension loads for category C2 for all embedment depths

Size	FAZ II, FAZ II A4, FAZ II C						
	M6	M8	M10	M12	M16	M20	M24
Displacement DLS $\delta_{N,C2(DLS)}$ [mm]	-		2,7	4,4		5,6	-
Displacement ULS $\delta_{N,C2(ULS)}$	-		11,5	13,0	12,3	14,4	-

Table C5.4: Displacements under shear loads for category C2 for all embedment depths

Size	FAZ II, FAZ II A4, FAZ II C						
	M6	M8	M10	M12	M16	M20	M24
Displacement DLS $\delta_{V,C2(DLS)}$ [mm]	-		4,1	4,7	5,5	4,8	-
Displacement ULS $\delta_{V,C2(ULS)}$	-		6,2	7,8	10,1	11,2	-

fischer Bolt Anchor FAZ II, FAZ II A4, FAZ II C

Performances
 Displacements under tension and shear loads

Annex C 5