

# Declaration of Performance

**2323-CPR-0050**

**1. Unique identification code of the product-type:** Mungo MQL plastic anchor for multiple use in concrete and masonry for non-structural applications

**2. Manufacturer:** Mungo Befestigungstechnik AG, Bornfeldstrasse 2, CH-4600 Olten/Switzerland

**3. System/s of AVCP:** System 2+

**4. Intended use or use/es:**

Product	Intended use
Plastic anchors for use in concrete and masonry	For use in systems, such as façade systems, for fixing or supporting elements which contribute to the stability of the systems

**5. European Assessment Document:** ETAG 020 Part 1: “Plastic anchors for multiple use in concrete and masonry for non-structural applications”, Edition March 2012, used as EAD

**European Technical Assessment:** ETA-11/0008 of 14 January 2020

**Technical Assessment Body:** DIBt – Deutsches Institut für Bautechnik

**Notified body/ies:** 305/2011 (Construction Product Regulation)

**6. Declared performance:**

**Mechanical resistance and stability (BWR 1)**

The essential characteristic regarding mechanical resistance and stability are included under the Basic Works Requirements Safety in use.

**Safety and accessibility (BWR 4)**

Essential characteristic	Performance
Characteristic resistance for tension and shear loads	See appendix, especially Annex C1 to C4
Characteristic resistance for bending moments	See appendix, especially Annex C1
Displacements under shear and tension loads	See appendix, especially Annex C1
Anchor distances and dimensions of members	See appendix, especially B2 to B3

**Safety in case of fire (BWR 1)**

Essential characteristic	Performance
Reaction to fire	Anchorage satisfy requirements for Class A1
Resistance to fire	See appendix, especially Annex C1

The performance of the product identified above is in conformity with the set of declared performance/s. This declaration of performance is issued, in accordance with Regulation (EU) No 305/2011, under the sole responsibility of the manufacturer identified above.

Signed for and on behalf of the manufacturer by:

Robert Klemencic Dipl.-Ing.

Head of Engineering



Olten, 20.02.2020



This DoP Has been prepared in different languages. In case there is a dispute on the interpretation the English version shall always prevail. The Appendix includes voluntary and complementary information in English language exceeding the (language as neutrally specified) legal requirements.

Installed condition for MQL 10

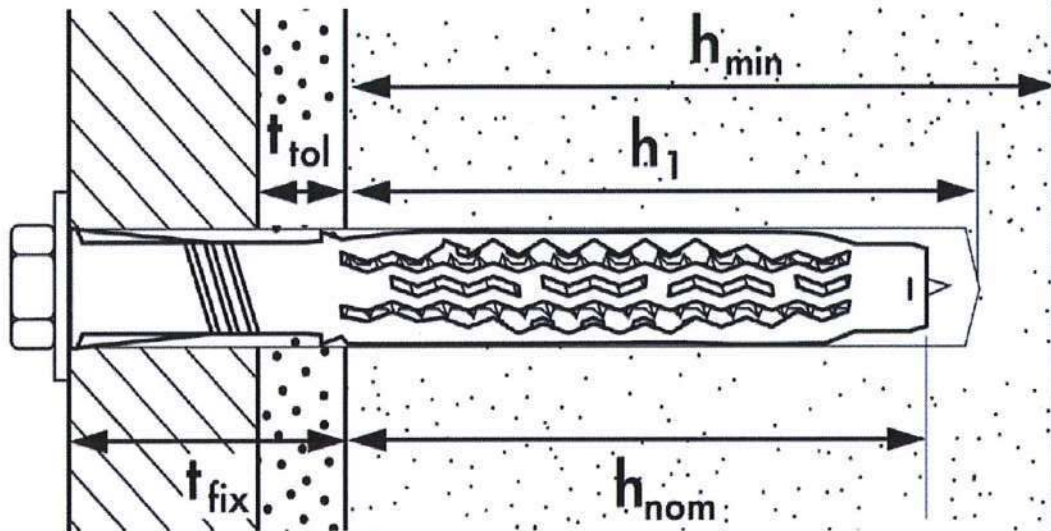

Legend

- $h_{min}$  = minimum thickness of structural part
- $h_1$  = depth of drilled hole to deepest point
- $t_{tol}$  = thickness of equalizing layer or non-load-bearing coating (non-structural layer)
- $t_{fix}$  = thickness of fixture (including non-load-bearing coating)
- $h_{nom}$  = overall anchor embedment depth in the base material

Mungo MQL Universal Frame Plug

Product description  
Installed condition

Annex A 1

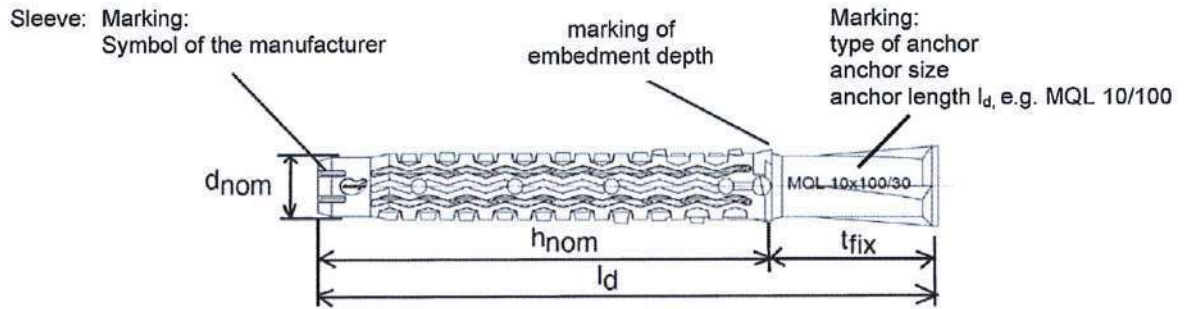

Version with broad collar:



Special screws:

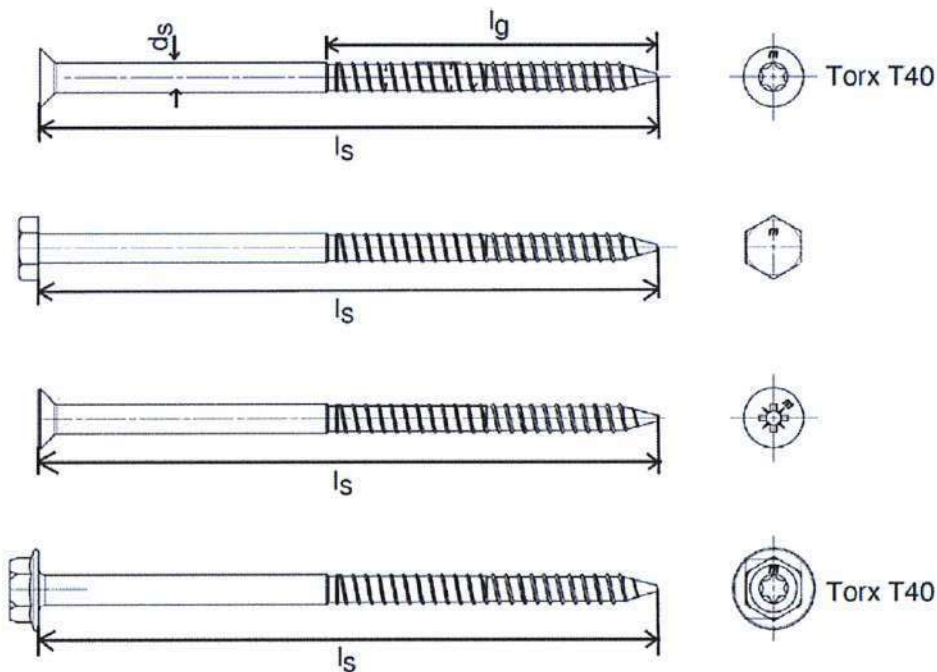

Mungo MQL Universal Frame Plug

Product description  
Anchor types and special screws

Annex A 2

**Table A1: Dimensions**

Anchor type	Plastic sleeve							Special screw <sup>2)</sup>		
	$h_{nom}$ [mm]	$d_{nom}$ [mm]	$t_{fix,min}$ [mm]	$t_{fix,max}$ [mm]	$l_d$ [mm]	$d_{kd}$ [mm]	$d_k$ [mm]	$d_s$ [mm]	$l_G$ [mm]	$l_{S,min}$ [mm]
<b>MQL 10<sup>1)</sup></b>	70	10	10	330	80 - 400	2	18	7	77	85

<sup>1)</sup> For description of the anchor the length of the plastic sleeve  $l_d$  is indicated additionally, e.g. for  $l_d=140$  mm: anchor MQL 10/ 140

<sup>2)</sup> The screw length  $l_s$  is 5 mm larger than the length of the plastic sleeve  $l_s$ , so the screw penetrates the appropriate plastic sleeve correctly.

**Table A2: Materials**

Name	Material
Plastic sleeve	Polyamide, PA6 colour orange
Special screw	steel 6.8, zinc plated $\geq 5\mu\text{m}$ acc. to EN ISO 4042:2018 blue passivated
	stainless steel A4 according to EN 10088-3:2014 material number 1.4401, 1.4301, 1.4571

**Mungo MQL Universal Frame Plug**

**Product description**  
Dimensions and materials

**Annex A 3**



### Specifications of intended use

#### Anchorage subject to:

- Static and quasi-static loads
- Multiple fixing of non-structural applications

**Table B1: Application categories in terms of base material and temperature range**

Application categories		See Annex	Anchor type MQL 10
<b>Base material</b> <sup>3)</sup>			
<b>a</b>	Reinforced or unreinforced normal weight concrete <sup>3)</sup> with strength classes $\geq$ C12/15 acc. to EN 206-1:2000/ A1:2004/ A2:2005	C 1	✓
<b>b</b>	Solid brick masonry <sup>1)2)3)</sup>	C 2	✓
<b>c</b>	Hollow brick masonry <sup>2)3)</sup>	C 3 + C 4	✓
<b>d</b>	Autoclaved aerated concrete	-	-
<b>Temperature range</b>			
<b>Tb</b>	min T = -20°C to +80°C (maximum short term temperature +80°C and maximum long term temperature +50°C)		✓
<sup>1)</sup> Note: The characteristic resistance is also valid for larger brick sizes and higher compressive strength. <sup>2)</sup> Clay bricks and calcium silicate bricks and mortar strength class $\geq$ M2,5 acc. to EN 998-2:2010 <sup>3)</sup> For other base materials of the use categories a, b or c the characteristic resistance of the anchor may be determined by job site tests according to ETAG 020, Annex B, Edition March 2012.			

#### Use conditions (environmental conditions):

- Structures subject to dry internal conditions (zinc coated steel, stainless steel).
- The specific screw made of galvanised steel may also be used in structures subject to external atmospheric exposure, if the area of the head of the screw is protected against moisture and driving rain after mounting of the fixing unit in this way, that intrusion of moisture into the anchor shaft is prevented. Therefore there shall be an external cladding or a ventilated rainscreen mounted in front of the head of the screw and the head of the screw itself shall be coated with a soft plastic, permanently elastic bitumen-oil-combination coating (e. g. undercoating or body cavity protection for cars).
- Structures subject to external atmospheric exposure (including industrial and marine environment) and to permanently damp internal condition, if no particular aggressive conditions exist (stainless steel).  
Note: Particular aggressive conditions are e.g. permanent, alternating immersion in seawater or the splash zone of seawater, chloride atmosphere of indoor swimming pools or atmosphere with extreme chemical pollution (e.g. in desulphurization plants or road tunnels where de-icing materials are used).

#### Design:

- The anchorages are to be designed in accordance with the ETAG 020, Annex C, Edition March 2012, under the responsibility of an engineer experienced in anchorages and masonry work.
- Verifiable calculation notes and drawings shall be prepared taking account of the loads to be anchored, the nature and strength of the base materials and the dimensions of the anchorage members as well as of the relevant tolerances. The position of the anchor is indicated on the design drawings.
- Fasteners are only to be used for multiple use for non-structural application according to ETAG 020, Edition March 2012.

#### Installation:

- Hole drilling by the drill modes according to Annex C1 - C4
- Anchor installation carried out by appropriately qualified personnel and under the supervision of the person responsible for technical matters of the site.
- Installation temperature from -20°C to +50°C
- Exposure to UV due to solar radiation of the anchor not protected  $\leq$  6 weeks

**Mungo MQL Universal Frame Plug**

**Intended use  
Specifications**

**Annex B 1**

**Table B2: Installation parameters**

Anchor type			ML 10
Base material			Concrete solid brick hollow brick
Overall anchor embedment depth in the base material <sup>1)2)</sup>	$h_{nom}$	[mm]	$\geq 70$
Nominal drill hole diameter	$d_{nom}$	[mm]	10
Cutting diameter of drill bit	$d_{cut}$	[mm]	$\leq 10,45$
Depth of drill hole to deepest point <sup>1)</sup>	$h_1$	[mm]	80
Diameter of clearance hole in fixture	$d_f$	[mm]	10,5

<sup>1)</sup> see Annex A 1

<sup>2)</sup> In masonry made of hollow or perforated bricks the influence of  $h_{nom} > 70$  mm has to be determined by job site tests according to ETAG 020, Annex B.

**Table B3: Minimum thickness of member, edge distance and spacing in concrete**

Anchor type	Strength category	Minimum thickness of member	Characteristic edge distance	Characteristic spacing	Minimum edge distance	Minimum spacing
		$h_{min}$	$c_{cr,N}$	$s_{cr,N}$	$c_{min}$	$s_{min}$
		[mm]	[mm]	[mm]	[mm]	[mm]
ML 10	C12/15	100	140	140	70	140
	$\geq C16/20$	100	100	100	50	100

Fixing points with spacing  $a \leq s_{cr,N}$  are considered as a group with a max. characteristic resistance  $N_{Rk,p}$  acc. to Table C3. For a spacing  $a > s_{cr,N}$  the anchors are considered as single anchors, each with a characteristic resistance  $N_{Rk,p}$  acc. to Table C3.

**Scheme of spacing and edge distances in concrete**

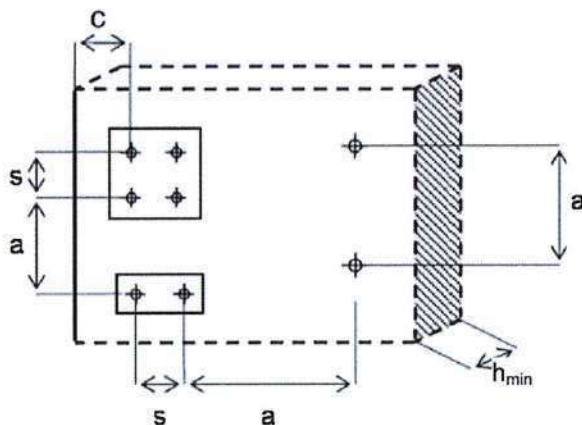

**Mungo MQL Universal Frame Plug**

**Intended use**  
Installation parameters, edge distance and spacing in concrete

**Annex B 2**



**Table B4: Minimale Bauteildicke, Randabstand und Achsabstand in Mauerwerk**

Base material	See Annex	Minimum member thickness	Minimum edge distance	Characteristic spacing	Minimum spacing	
					vertical to edge	parallel to edge
					$s_{1,min}$	$s_{2,min}$
		$h_{min}$	$c_{min}$	$a_{min}$		
		[mm]	[mm]	[mm]	[mm]	[mm]
Solid clay brick Mz 20/2,0 - 2DF	C 2	115	100	max (250 mm, $s_{1,min}$ , $s_{2,min}$ )	200	400
Solid calcium silicate bricks KS 12/2,0 - 2DF	C 2	115				
Hollow clay brick HLz 12/1,2 - 10DF	C 3	240				
Ital. Hollow clay brick Mattone	C 3	240				
Calcium silicate hollow brick KSL 12/1,2-10DF	C 4	240				

**Scheme of spacing and edge distances in masonry**

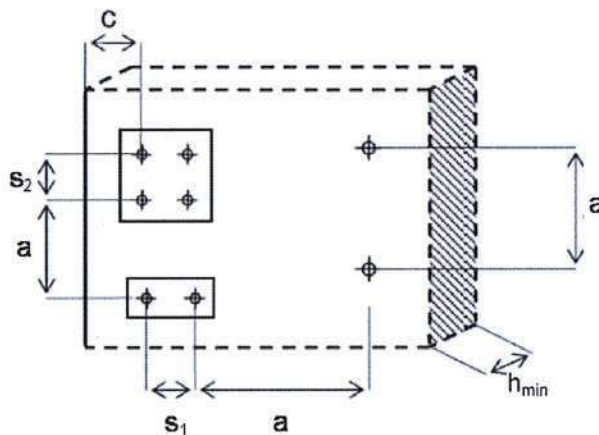

Mungo MQL Universal Frame Plug

**Intended use**  
Edge distance and spacing in masonry

**Annex B 3**

### Installation instructions in concrete and solid brick:

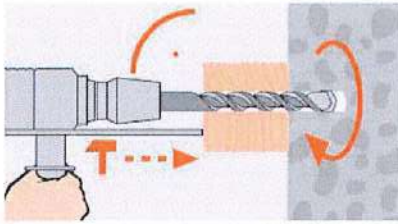

Drill the hole by **hammer drilling**.  
Chose drill diameter and drill hole depth according to Table B2.  
Temperature of base material  $\geq -20^{\circ}\text{C}$ .

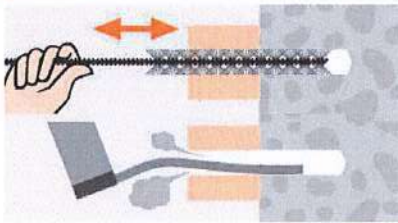

Pre-cleaning the drill hole with a brush, then hole-blowing with a pump.

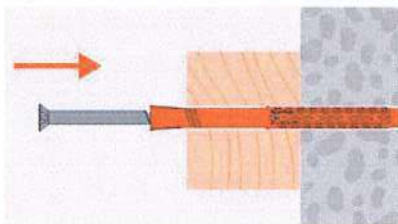

Setting the anchor with the preassembled fastener through the part to be fixed.

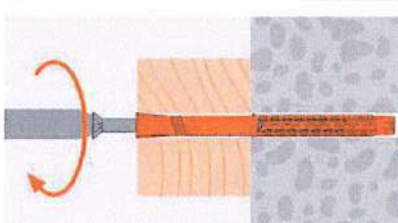

Push the anchor till the collar of the sleeve contacts the part to be fixed, then fix the part with screw.

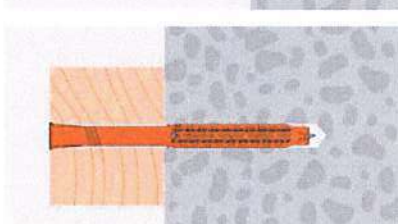

Tightening the fastener until sleeve collar contact.

Electronic copy of ETA by DIBt: ETA-11/0008

Mungo MQL Universal Frame Plug

Intended use  
Installation instructions in concrete and solid brick

Annex B 4



### Installation instructions in hollow brick:

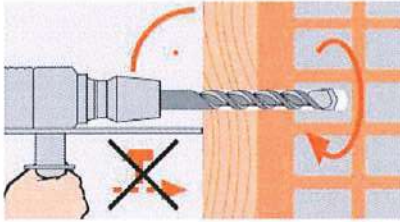

Drill the hole according to the method given in Table C6 and C7 by **rotary drilling** (without hammering) or **hammer drilling**.  
Chose drill hole diameter and drill hole depth according to Table B2.  
Temperature of base material  $\geq -20^{\circ}\text{C}$ .

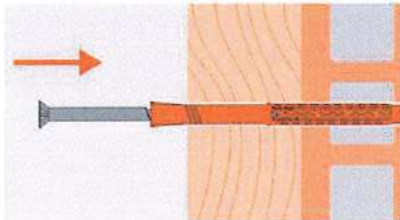

Setting the anchor with the preassembled fastener through the part to be fixed.

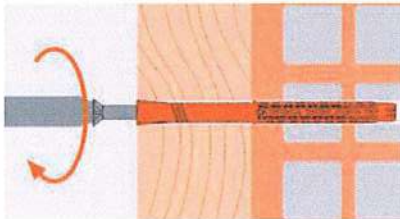

Push the anchor until the collar contacts the part to be fixed, then fix the part with screw.

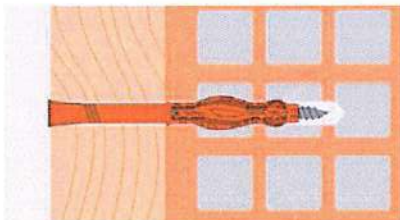

Tighten the fastener until sleeve collar contact.

Electronic copy of ETA by DIBt: ETA-11/0008

Mungo MQL Universal Frame Plug

Intended use  
Installation instructions in hollow brick

Annex B 5

**Table C1: Characteristic bending resistance of the special screw**

Anchor type			MQL 10	
Steel type			Zinc plated steel	Stainless steel
Characteristic bending resistance	$M_{Rk,s}$	[Nm]	15,3	17,8
Partial safety factor	$\gamma_{Ms}^{1)}$	[-]	1,25	1,56

<sup>1)</sup> In absence of other national regulations.

**Table C2: Characteristic resistance of the screw**

Anchor type			MQL 10	
Failure of expansion element (special screw)			Zinc plated steel	Stainless steel
Characteristic tension resistance	$N_{Rk,s}$	[kN]	17,0	19,8
Partial safety factor for $N_{Rk,s}$	$\gamma_{Ms}^{1)}$	[-]	1,5	1,87
Characteristic shear resistance	$V_{Rk,s}$	[kN]	8,5	8,5
Partial safety factor for $V_{Rk,s}$	$\gamma_{Ms}^{1)}$	[-]	1,25	1,56

<sup>1)</sup> In absence of other national regulations.

**Table C3: Characteristic resistance in in concrete (use category a)**

Anchor type			MQL 10
Drilling method			Hammer drilling
<b>Pullout failure (plastic sleeve)</b>			
<b>concrete C12/15</b>			
Characteristic resistance $50^{\circ}\text{C}^{1)}$ / $80^{\circ}\text{C}^{2)}$	$N_{Rk,p}$	[kN]	1,5
<b>concrete <math>\geq</math> C16/20</b>			
Characteristic resistance $50^{\circ}\text{C}^{1)}$ / $80^{\circ}\text{C}^{2)}$	$N_{Rk,p}$	[kN]	2,5

<sup>1)</sup> Maximum long term temperature

<sup>2)</sup> Maximum short term temperature

**Table C4: Displacements<sup>1)</sup> under tension and shear load in concrete and masonry**

Anchor type	Tension load			Shear load		
	$F^{2)}$	$\delta_{N0}$	$\delta_{N\infty}$	$F^{2)}$	$\delta_{V0}$	$\delta_{V\infty}$
	[kN]	[mm]	[mm]	[kN]	[mm]	[mm]
<b>MQL 10</b>	1,0	0,06	0,12	4,5	3,0 <sup>3)</sup>	4,5 <sup>3)</sup>

<sup>1)</sup> Valid for all temperature ranges.

<sup>2)</sup> Intermediate values by linear interpolation.

<sup>3)</sup> The displacements under shear load may increase in case of an annular gap in the fixture.

**Tabelle C5: Values under fire exposure in concrete C20/25 to C50/60 in any load direction, non-permanent centric load and whitout lever arm**

Anchor type	Fire resistance class	$F^{1)}$
<b>MQL 10</b>	R 90	$\leq 0,8$ kN

<sup>1)</sup>  $F = F_{Rk} / (\gamma_M \cdot \gamma_F)$

**Mungo MQL Universal Frame Plug**

**Performances**

Characteristic resistance in concrete, characteristic resistance of the screw displacements under tension and shear load in concrete and masonry

**Annex C 1**

**Table C5: Characteristic resistance for MQL 10 in solid masonry (use category b) –  
clay brick and calcium silicate brick**

Base material	Geometry (format/ length/ width/ height) [cm]	Min. compressive strength $f_b$ [N/mm <sup>2</sup> ] bulk density $\geq \rho$ [kg/dm <sup>3</sup> ]	Drilling method <sup>1)</sup>	Characteristic resistance $F_{Rk}$ [kN]
				MQL 10
<b>Clay solid brick 2DF 240mm/ 115mm / 113mm acc. to EN 771-1:2011 / DIN 105-100:2012-01</b>				
Mz 20/2,0		10 / 2,0	H	2,0
		20 / 2,0	H	3,0
<b>Calcium silicate solid brick 2DF 240mm/ 115mm/ 113mm acc. to EN 771-2:2011 / DIN V 106:2005-10</b>				
KSV 12/2,0		10 / 2,0	H	1,5
		20 / 2,0	H	2,5

<sup>1)</sup> H = Hammer drilling; R = Rotary drilling



**Mungo MQL Universal Frame Plug**

**Performances**  
Characteristic resistances in solid masonry

**Annex C 2**

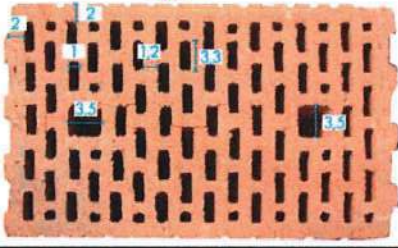

**Table C6: Characteristic resistance for MQL 10 in hollow or perforated masonry (use category c) – clay brick**

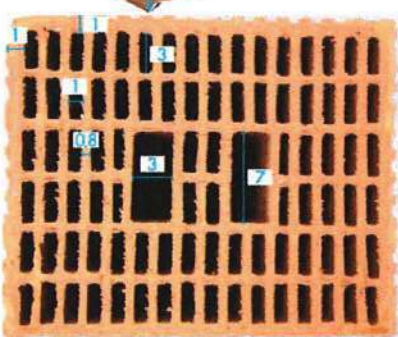
Base material	Geometry (format/ length/ width/ height) [cm]	Min. compressive strength $f_b$ [N/mm <sup>2</sup> ] bulk density $\geq \rho$ [kg/dm <sup>3</sup> ]	Drilling method <sup>1)</sup>	Characteristic resistance $F_{Rk}$ [kN]
				MQL 10
Clay brick 10DF 300mm/ 240mm/ 240mm and 300mm/ 240mm/ 195mm with perforation acc. to EN 771-1:2011 / DIN 105-100:2012-01				
HLz 12/1,2		12 / 1,2	R	1,2 <sup>2)</sup>
		20 / 1,2	R	2,0 <sup>2)</sup>
Ital. perforated brick Mattone		10 / 0,84	R	0,9 <sup>2)</sup>
				

<sup>1)</sup> H = Hammer drilling; R = Rotary drilling

<sup>2)</sup> Shear load with lever arm is not allowed.

**Mungo MQL Universal Frame Plug**

**Performances**

Characteristic resistances in hollow masonry

**Annex C 3**

**Table C7: Characteristic resistance for MQL 10 in hollow or perforated masonry (use category c) – calcium silicate brick**

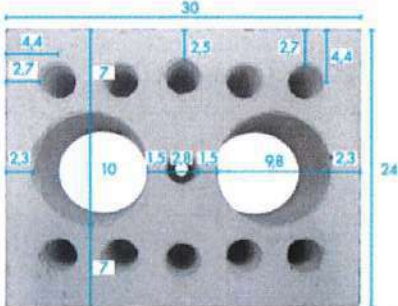
Base material	Geometry (format/ length/ width/ height) [cm]	Min. compressive strength $f_b$ [N/mm <sup>2</sup> ] bulk density $\geq \rho$ [kg/dm <sup>3</sup> ]	Drilling method <sup>1)</sup>	Characteristic resistance $F_{Rk}$ [kN]
				MQL 10
Calcium silicate brick 300mm / 240mm/ 115mm with perforation acc. to EN 771-2:2011 / DIN V 106:2005-10				
KSL 12/1,4		8 / 1,4	H	1,2 <sup>2)</sup>
				

<sup>1)</sup> H = Hammer drilling; R = Rotary drilling

<sup>2)</sup> Shear load with lever arm is not allowed.

Mungo MQL Universal Frame Plug

**Performances**  
Characteristic resistances in hollow masonry

**Annex C 4**